

OPC UA I/O User Manual

V10.0, 2025/06

U-7500 Series

IIoT OPC UA I/O Module

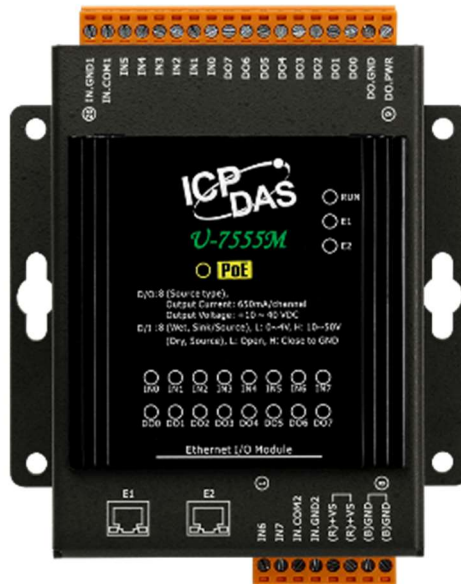

Technical support: service@icpdas.com

Technical Editor: Tim Chen

Editor: Eva Li

Last Editor: Carol Hsu

Warranty

All products manufactured by ICP DAS are under warranty regarding defective materials for a period of one year, beginning from the date of delivery to the original purchaser.

Warning

ICP DAS assumes no liability for any damage resulting from the use of this product. ICP DAS reserves the right to change this manual at any time without notice.

The information furnished by ICP DAS is believed to be accurate and reliable. However, no responsibility is assumed by ICP DAS for its use, not for any infringements of patents or other rights of third parties resulting from its use.

Copyright

Copyright © 2020 by ICP DAS Co., Ltd. All rights are reserved.

Trademark

The names used for identification only may be registered trademarks of their respective companies.

Contact US

If you have any problem, please feel free to contact us.

You can count on us for quick response.

Email: service@icpdas.com

For more product information please refer to website: <https://www.icpdas.com>

Revision History

This chapter provides revision history information to this document.

The table below shows the revision history.

Revision	Date	Description
V10.0	06/2025	10.0 th Version: Provide New Functions: 1. 1. 4.5.1, 4.5.2 Order of chapter exchanges 2. 4.3.2 Server- Add the statement "File extension: .der, .cer, and .crt. only" 3. .4.3.3. Client Setting- Replace the interface diagram 4. 4.3.1 Server Settings- Add the statement that the OPC UA Server supports IPv4 only.
V9.1	03/2025	9.1 th Version: Provide New Functions: 5. Increase software specification -Basic256Sha256 (Sign, Sign and Encrypt) - Aes128Sha256RsaOaep (Sign, Sign & Encrypt) - Aes256Sha256RsaPss (Sign, Sign & Encrypt) 6. Modify the contents of the project file 4.2.5 7. 4.3.1 Add security settings, change connection setting diagram 8. 4.3.3 Modify the security policy content 9. 4.2.2 Set the analog input channels individually to enable or disable. 10. 4.5.4 Add the Nickname column. 11. 4.1.7 Replaces the maintenance interface diagram 12. 4.1.7 Delete 'Wait about 2 minutes' in the firmware settings. 13. 4.3.3 OPC UA Server supports IPv4 only. 14. 4.5.1.2 Modify the send message to the Line chapter
V9.0	12/2023	9 th Version: Provide New Functions: 1. (4.3.1) (4.3.3) Replace the web interface picture. 2. 2.1.3 Refill notes 3. Delete the 3.5 rule setting. 4. 4.3.1 Add the option to automatically trust all client certificates in the connection settings. 5. Rewrite the content of the "Add new rule" function.
V8.0	09/2023	8 th Version: Provide New Functions: 1. Modify the UA I/O manual introduction, features, and specifications. 2. Add Client Setting function 3. Add Client certificate function 4. Add EZ-UAQ Utility
V7.1	05/2023	7.1 th Version: Provide New Functions: 1. 1. 4.5.1 New Line function and step-by-step procedure in the event log. The setting is changed to 4.5.1.1 Main settings 2. Add new function 4.5.1.2 Sending messages to Line

Revision	Date	Description
		<ol style="list-style-type: none"> 3. 4.5.2 rule setting add 4.5.2.1 main settings, optimize the setting process 4. 4. (4.2.3) (4.2.4) (4.4.2) The Nickname in the function of [Module Setting] → [I/O Setting] 5. 2.2.2 Original Utility changed to EZ-UAQ Utility content update
V7.0	02/2023	<p>7th Version: Provide New Models & New Functions:</p> <ol style="list-style-type: none"> 1. Add new models (*18): U-7502M, 7515M, 7517M, 7518ZM/S, 7518ZM/S2, 7524M, 7528M, 7542M, 7544M, 7545M, 7550AM, 7551M, 7552M, 7553M, 7558M, 7559M, 7561M, 7567M 2. Add new function: Support IoTstar Cloud management software (3.5 and 4.5.6) 3. Add new models to each section of CH1. 4. 2.2.2 Utility upgrade 5. Add counter function to the I/O setting (4.2.1) 6. Add the Test function to the MQTT Setting. (3.2.1 and 4.4.1) 7. InduSoft changed to AVEVA Edge 8. lotstar added new features 9. Add 3.4 Common settings table for easy integration 10. Add 4.2.1 Overview 11. Alias changed to Nickname 12. chapter order changed Scaling 4.5.1→4.2.3
V6.0	04/2022	<p>6th Version: Provide New Models & New Functions:</p> <ol style="list-style-type: none"> 1. Add new models: U-7517M-10 \ U-7519ZM(/S, /S2) 2. Add more descriptions for the 3.3, 4.1, 4.4, and 4.5 sections. 3. Add new models to each section of CH1.

Table of Contents

Revision History	3
Table of Contents	5
1. UA I/O Introduction:	17
1.1 Introduction.....	17
1.2 Features	19
1.3 Selection Guide	21
1.4 Specifications.....	23
1.4.1 Software Specifications (Series Common)	23
1.4.2 U-7502M Specifications.....	24
1.4.3 U-7504M Specifications.....	25
1.4.4 U-7515M Specifications.....	26
1.4.5 U-7517M Specifications.....	27
1.4.6 U-7517M-10 Specifications.....	28
1.4.7 U-7518ZM/S, U-7518ZM/S2 Specifications	29
1.4.8 U-7519ZM/S, U-7519ZM/S2 Specifications	30
1.4.9 U-7524M Specifications.....	31
1.4.10 U-7526M Specifications.....	32
1.4.11 U-7528M Specifications.....	33
1.4.12 U-7542M Specifications.....	34
1.4.13 U-7544M Specifications.....	35
1.4.14 U-7545M Specifications.....	36
1.4.15 U-7550AM Specifications	37
1.4.16 U-7551M Specifications.....	38
1.4.17 U-7552M Specifications.....	39
1.4.18 U-7553M Specifications.....	40
1.4.19 U-7555M Specifications.....	41
1.4.20 U-7558M Specifications.....	42
1.4.21 U-7559M Specifications.....	43
1.4.22 U-7560M Specifications.....	44
1.4.23 U-7561M Specifications.....	45
1.4.24 U-7567M Specifications.....	46
1.5 Wire Connections / Pin Assignments.....	47
1.5.1 U-7502M Wire Connections / Pin Assignments/Jumper Pic	47
1.5.2 U-7504M Wire Connections / Pin Assignments/Jumper Pic	48

1.5.3 U-7515M Wire Connections / Pin Assignments	49
1.5.4 U-7517M Wire Connections/Pin Assignments/Jumper Pic	50
1.5.5 U-7517M-10 Wire Connections/Pin Assignments/Jumper Pic	51
1.5.6 U-7518ZM Wire Connections/Pin Assignments	52
1.5.7 U-7519ZM Wire Connections/Pin Assignments/Jumper Pic	53
1.5.8 U-7524M Wire Connections/Pin Assignments/Jumper Pic	54
1.5.9 U-7526M Wire Connections/Pin Assignments/Jumper Pic	55
1.5.10 U-7528M Wire Connections/Pin Assignments/Jumper Pic	56
1.5.11 U-7542M Wire Connections/Pin Assignments	57
1.5.12 U-7544M Wire Connections/Pin Assignments	58
1.5.13 U-7545M Wire Connections/Pin Assignments	59
1.5.14 U-7550AM Wire Connections/Pin Assignments	60
1.5.15 U-7551M Wire Connections/Pin Assignments	61
1.5.16 U-7552M Wire Connections/Pin Assignments	62
1.5.17 U-7553M Wire Connections/Pin Assignments	63
1.5.18 U-7555M Wire Connections / Pin Assignments	64
1.5.19 U-7558M Wire Connections/Pin Assignments	65
1.5.20 U-7559M Wire Connections/Pin Assignments	66
1.5.21 U-7560M Wire Connections / Pin Assignments	67
1.5.22 U-7561M Wire Connections/Pin Assignments	68
1.5.23 U-7567M Wire Connections/Pin Assignments	69
1.6 Dimensions	70
U-7502M/U-7504M/U-7515M/U-7517M/U-7517M-10/U-7524M /U-7526M/U-7528M/U-7542M/U-7544M/U-7545M/U-7550AM /U-7551M/U-7552M/U-7553M/U-7555M/U-7558M/U-7559M /U-7560M/U-7561M/U-7567M Dimensions	70
U-7518ZM/U-7519ZM Dimensions	71
2. Quick Start: Hardware/Network Connection.....	72
2.1. Hardware Connection	72
2.1.1. Preparations for Devices	72
2.1.2. AI/AO Jumper Setting	72
2.1.3. Hardware Wiring	74
2.2. Network Connection	75
2.2.1. Connection by Factory Default Settings (For New UA).....	76
2.2.2. Connection by Utility Searching	79
3. Main Function Settings.....	82
3.1 Settings for Using OPC UA Connection.....	83
3.1.1 OPC UA Server Connection Settings (UA I/O)	84
3.1.2 OPC UA Client Side: AVEVA Edge Simple Application	85

3.1.3 Secure Encrypted Connection: OPC UA Certificate	86
3.2 Settings for Using MQTT Connection	87
3.2.1 Connecting to MQTT Broker	88
3.2.2 MQTT Client Setting of the UA I/O	89
3.2.3 Secure Encrypted Connection: MQTT Certificate	94
3.3 RESTful API: Read and Write I/O and Virtual Point.....	95
What is Restful API?	95
Use RESTful with UA I/O	95
RESTful Description.....	97
Use RESTful API HTTPS with UA I/O	100
3.4 Common settings table for easy integration.....	101
Setting Steps:.....	101
3.5 IoTstar Connection Example	103
4. Main Menu: Parameter Descriptions	105
4.1 Main Menu - System Setting.....	105
4.1.1 Overview.....	105
4.1.2 Network Setting	106
Network Setting (LAN).....	106
Hostname Setting.....	107
4.1.3 Time Setting	108
Date and Time Display	108
NTP time calibration	109
Set the time manually.....	109
4.1.4 Account Setting	110
Administrator Setting	110
User Setting	112
4.1.5 Web Server Setting.....	113
Http Web Server Setting.....	113
Https Web Server Setting.....	114
RESTful API 115	
4.1.6 Firewall Setting	117
4.1.7 Firmware Setting	118
Restore Factory Setting.....	118
Update Firmware.....	120
Maintenance	122
4.2 Main Menu - Module Setting	123
4.2.1 I Overview.....	123
Function Overview	123
Download the file from device	124
4.2.2 I/O Setting.....	125
Digital Input	125
Digital Output	126
Analog Input.....	127

Analog Output	128
4.2.3 Scaling	129
4.2.4 I/O Status.....	130
Digital Input (& Counter).....	130
Digital Output	131
Analog Input.....	132
Analog Output	133
4.2.5 Project File.....	134
Download the file from device	134
Upload the file to the device	135
4.3 Main Menu - OPC UA Setting.....	137
4.3.1 Server Setting.....	138
4.3.2 Server Certificate	140
4.3.3 Client Setting	141
4.3.4 Client Certificate	143
4.4 Main Menu – MQTT Setting.....	144
4.4.1 Connection Setting	144
4.4.2 Client Setting	145
4.4.3 Certificate	148
4.5 Main Menu – Advanced Setting	150
4.5.1 Logic Control	150
4.5.1.1 Rule Settings.....	150
4.5.1.2. Scenario Control.....	152
4.5.1.3 Schedule	154
4.5.2 I/O Trigger Message	156
4.5.2.1 Msgs→File(CSV).....	156
4.5.2.2 Msgs→Line	159
Line message sending test	159
Event Log + Line Settings	159
4.5.3 IoTstar Setting	161
4.5.4 EZ-UAQ Utility	163
5. Recovering Firmware Setting (Reset)	164
Appendix A. Menu Path Diagram Description	166
Appendix B. MQTT JSON Format of the UA I/O Series.....	167
Appendix C. Dead Band Description.....	168

List of Figures

Figure 1	1-1 OPC UA Architecture.....	17
Figure 2	1-1 MQTT Architecture	18
Figure 3	1-5-1 U-7502M Wire Connections / Pin Assignments/Jumper Pic.....	47
Figure 4	1-5-2 U-7504M Wire Connections / Pin Assignments/Jumper Pic.....	48
Figure 5	1-5-3 U-7515M Wire Connections / Pin Assignments.....	49
Figure 6	1-5-4 U-7517M Wire Connections/Pin Assignments/Jumper Pic.....	50
Figure 7	1-5-5 U-7517M-10 Wire Connections/Pin Assignments/Jumper Pic	51
Figure 8	1-5-6 U-7518ZM Wire Connections/Pin Assignments.....	52
Figure 9	1-5-7 U-7519ZM Wire Connections/Pin Assignments/Jumper Pic.....	53
Figure 10	1-5-8 U-7524M Wire Connections/Pin Assignments/Jumper Pic.....	54
Figure 11	1-5-9 U-7526M Wire Connections/Pin Assignments/Jumper Pic.....	55
Figure 12	1-5-10 U-7528M Wire Connections/Pin Assignments/Jumper Pic.....	56
Figure 13	1-5-11 U-7542M Wire Connections/Pin Assignments.....	57
Figure 14	1-5-12 U-7544M Wire Connections/Pin Assignments.....	58
Figure 15	1-5-13 U-7545M Wire Connections/Pin Assignments.....	59
Figure 16	1-5-14 U-7550AM Wire Connections/Pin Assignments	60
Figure 17	1-5-15 U-7551M Wire Connections/Pin Assignments.....	61
Figure 18	1-5-16 U-7552M Wire Connections/Pin Assignments.....	62
Figure 19	1-5-17 U-7553M Wire Connections/Pin Assignments.....	63
Figure 20	1-5-18 U-7555M Wire Connections / Pin Assignments.....	64
Figure 21	1-5-19 U-7558M Wire Connections/Pin Assignments.....	65
Figure 22	1-5-20 U-7559M Wire Connections/Pin Assignments.....	66
Figure 23	1-5-21 U-7560M Wire Connections / Pin Assignments.....	67
Figure 24	1-5-22 U-7561M Wire Connections/Pin Assignments.....	68
Figure 25	1-5-23 U-7567M Wire Connections/Pin Assignments.....	69
Figure 26	1-6 Dimensions	70
Figure 27	1-6 U-7518ZM/U-7519ZM Dimensions	71
Figure 28	2-1-2 Voltage/Current Input/output Selection Jumper	72
Figure 29	2-1-3 Hardware Wiring(Fig.1)	74
Figure 30	2-1-3 Hardware Wiring(Fig.2)	74
Figure 31	2-2 Use IP to login to UA I/O Web UI Web UI.....	75
Figure 32	2-2-1 Use root/ root to login to UA I/O Web UI	76
Figure 33	2-2-1 Change the Username/password.....	77
Figure 34	2-2-1 Password Setting Rules.....	77
Figure 35	2-2-1 Network Setting(LAN1).....	78

Figure 36	2-2-1 Use the new IP to login the Web UI of UA I/O	78
Figure 37	2-2-2 Download and install the Utility (EZ-UAQ Utility)	79
Figure 38	2-2-2 EZ-UAQ Utility Web Interface	79
Figure 39	2-2-2 2 Search the UA/BRK/UA_IO series modules	80
Figure 40	2-2-2 3 Connect to the UA I/O Series	80
Figure 41	2-2-2 Connection to the UA I/O Web UI	81
Figure 42	2-2-2 Login the Web UI of the UA I/O Series	81
Figure 43	3 OPC UA / MQTT Communication Advantages	82
Figure 44	3-1 OPC UA Architecture and Advantages of the UA I/O	83
Figure 45	3-1-1 OPC UA Server Connection Setting (UA I/O)	84
Figure 46	3-1-1 OPC UA Server Account Setting (UA I/O)	84
Figure 47	3-1-2 OPC UA Client Side: AVEVA Edge Simple Application.....	85
Figure 48	3-1-3 Download the file from device(1)	86
Figure 49	3-1-3 Download the file from device(2)	86
Figure 50	3-1-3 Upload the file to the device(1)	86
Figure 51	3-1-3 Upload the file to the device(2)	86
Figure 52	3-2 Comparison between UA I/O modules and traditional I/O modules.....	87
Figure 53	3-2-1 Connecting to MQTT Broker.....	88
Figure 54	3-2-2 Subscribe/Distribute Architecture.....	89
Figure 55	3-2-2 MQTT Client Setting of the UA I/O	90
Figure 56	3-2-2 JSON Format Enable/Disable Setting	90
Figure 57	3-2-2 MQTT Setting > Client Setting - Publish & Subscribe(1).....	91
Figure 58	3-2-2 MQTT Setting > Client Setting - Publish & Subscribe(2).....	91
Figure 59	3-2-2 Group Setting example: Check “Enable” of “JSON Format”(1)	92
Figure 60	3-2-2 Group Setting example: Check “Enable” of “JSON Format”(2)	92
Figure 61	3-2-2 Singly Setting example: Uncheck “Enable” of “JSON Format”(1)	93
Figure 62	3-2-2 Singly Setting example: Uncheck “Enable” of “JSON Format”(2)	93
Figure 63	3-2-3 Secure Encrypted Connection: MQTT Certificate	94
Figure 64	3-3 Restful API [Example 1-1]	95
Figure 65	3-3 Restful API [Example 1-2]	95
Figure 66	3-3 Restful API [Example 2-1]	96
Figure 67	3-3 Restful API [Example 2-2]	96
Figure 68	3-3 Restful API [Example 3].....	96
Figure 69	3-3 RESTful API HTTPS Web Server Setting.....	100
Figure 70	3-3 https://IP:Port/Resource Definition	100
Figure 71	3-4 Common settings(1)	101
Figure 72	3-4 Common settings(2)	102

Figure 73	3-4 Common settings(3)	102
Figure 74	3-4 Common settings(4)	102
Figure 75	3-5 IoTstarLive Demo webpage	103
Figure 76	3-5 Connection Setting	104
Figure 77	4-1-1 System Setting	105
Figure 78	4-1-2 Network Setting (LAN)	106
Figure 79	4-1-2 Hostname Setting	107
Figure 80	4-1-3 Date and Time Display	108
Figure 81	4-1-3 Time Setting-Please check the time	108
Figure 82	4-1-3 NTP time calibration	109
Figure 83	4-1-3 Set the time manually	109
Figure 84	4-1-4 Account Setting	110
Figure 85	4-1-4 Login Error Notiifcation	111
Figure 86	4-1-4 User Setting	112
Figure 87	4-1-5 Web Server Setting(1)	113
Figure 88	4-1-5 Web Server Setting(2)	114
Figure 89	4-1-5 RESTful API-Request Method GET/Design	115
Figure 90	4-1-5 RESTful API-Request Method PUT/Design	116
Figure 91	4-1-6 Firewall Setting	117
Figure 92	4-1-7 Restore factory setting(1)	118
Figure 93	4-1-7 Restore factory setting(2)	118
Figure 94	4-1-7 Restore factory setting(3)	119
Figure 95	4-1-7 Update Firmware(1)	120
Figure 96	4-1-7 Update Firmware(2)	120
Figure 97	4-1-7 Update Firmware(3)	120
Figure 98	4-1-7 Update Firmware(4)	121
Figure 99	4-1-7 Update Firmware(5)	121
Figure 100	4-1-7 Maintenance	122
Figure 101	4-2-1 Function Overview	123
Figure 102	4-2-1 Download the file from device	124
Figure 103	4-2-2 I/O Setting-Digital Input	125
Figure 104	4-2-2 I/O Setting-Digital Output	126
Figure 105	4-2-2 I/O Setting-Analog Input	127
Figure 106	4-2-2 I/O Setting-Analog Output	128
Figure 107	4-2-3 Module Setting-Scaling	129
Figure 108	4-2-4 I/O Status-Digital Input	130
Figure 109	4-2-4 I/O Status-Digital Output	131

Figure 110	4-2-4 I/O Status-Analog Input.....	132
Figure 111	4-2-4 I/O Status-Analog Output.....	133
Figure 112	4-2-5 Download the file from device(1)	134
Figure 113	4-2-5 Download the file from device(2)	135
Figure 114	4-2-5 Download the file from device(3)	136
Figure 115	4-3 OPC UA Setting-Please remove the server certifiicate.....	137
Figure 116	4-3-1 Server Setting-Connection Settings.....	138
Figure 117	4-3-2 Server Certificate.....	140
Figure 118	4-3-3 Client Setting-Functional Status	141
Figure 119	4-3-3 Client Setting-Connection Setting	141
Figure 120	4-3-3 Client Setting-Connect and get the Node Id	142
Figure 121	4-3-4 Client Certificate-Download the file from device.....	143
Figure 122	4-4-1 MQTT Broker Connection Setting	144
Figure 123	4-4-2 Client Setting-Content Setting.....	145
Figure 124	4-4-2 JSON Format-Enable.....	146
Figure 125	4-4-2 JSON Format-Not Enable.....	147
Figure 126	4-4-3 Certificate-SSL/TLS is not enable	148
Figure 127	4-4-3 One/Two-way Authentication Screen	149
Figure 134	4-5-2 Rule Information Setting	150
Figure 135	4-5-2 Rule Setting-Advanced Setting	151
Figure 136	4-5-2-2 I/O Control(1)	152
Figure 137	4-5-2-2 I/O Control(2)	152
Figure 138	4-5-2-2 I/O Control-Setting.....	153
Figure 139	4-5-2-3 Schedule-Rule Setting List.....	154
Figure 140	4-5-2-3 Schedule-Content Setting	154
Figure 141	4-5-2-3 Schedule-Cycle/Specified Range/Exclude	155
Figure 128	4-5-1 Event Log-Digital Input/Output	156
Figure 129	4-5-1 Event Log-Analog Input/Output	157
Figure 130	4-5-1 Event Log-Log File Download	158
Figure 131	4-5-1-2 Line message sending test	159
Figure 132	4-5-1-2 Event Log + Line Settings (1)	159
Figure 133	4-5-1-2 Event Log + Line Settings (2)	160
Figure 142	4-5-3 IoTstar Setting-Connection Setting.....	162
Figure 143	4-5-4 EZ-UAQ Utility Settings.....	163
Figure 144	5 Recovering Firmware Setting(1)	164
Figure 145	5 Recovering Firmware Setting(2)	164
Figure 146	5 Recovering Firmware Setting(3)	164

Figure 147 5 Recovering Firmware Setting(4)164

Figure 148 Appendix A. Menu Path Diagram Description (example 1).....166

Figure 149 Appendix A. Menu Path Diagram Description (example 2).....166

Figure 150 Appendix B. MQTT JSON Format of the UA I/O Series167

Figure 151 Appendix C. Dead Band Description.....168

List of Tables

Table 1	1-1 Connectivity for various platforms.....	17
Table 2	1-3 U-7500 Series UA I/O Selection Guide	21
Table 3	1-4-1 Software Specifications.....	23
Table 4	1-4-2 U-7502M Specifications	24
Table 5	1-4-3 U-7504M Specifications	25
Table 6	1-4-4 U-7515M Specifications	26
Table 7	1-4-5 U-7517M Specifications	27
Table 8	1-4-6 U-7517M-10 Specifications.....	28
Table 9	1-4-7 U-7518ZM/S, U-7518ZM/S2 Specifications	29
Table 10	1-4-8 U-7519ZM/S, U-7519ZM/S2 Specifications	30
Table 11	1-4-9 U-7524M Specifications	31
Table 12	1-4-10 U-7526M Specifications	32
Table 13	1-4-11 U-7528M Specifications.....	33
Table 14	1-4-12 U-7542M Specifications	34
Table 15	1-4-13 U-7544M Specifications	35
Table 16	1-4-14 U-7545M Specifications	36
Table 17	1-4-15 U-7550AM Specifications.....	37
Table 18	1-4-16 U-7551M Specifications	38
Table 19	1-4-17 U-7552M Specifications	39
Table 20	1-4-18 U-7553M Specifications	40
Table 21	1-4-19 U-7555M Specifications	41
Table 22	1-4-20 U-7558M Specifications	42
Table 23	1-4-21 U-7559M Specifications	43
Table 24	1-4-22 U-7560M Specifications	44
Table 25	1-4-23 U-7561M Specifications	45
Table 26	1-4-24 U-7567M Specifications	46
Table 27	2-2-1 Factory Default Settings of UA I/O Modules (1)	76
Table 28	2-2-1 Factory Default Settings of UA I/O Modules (2)	76
Table 29	3-2-2 MQTT Setting > Client Setting - Publish & Subscribe.....	91
Table 30	3-3 RESTful [Resource Definition]	97
Table 31	3-3 RESTful [JSON Description]	97
Table 32	3-3 RESTful [GET Examples].....	98
Table 33	3-3 RESTful [PUT Examples]	99
Table 34	4-1-1 System Setting-Overview	105
Table 35	4-1-2 Network Setting (LAN)	106

Table 36	4-1-2 Hostname Setting	107
Table 37	4-1-3 Date and Time Display	108
Table 38	4-1-3 NTP time calibration	109
Table 39	4-1-3 Set the time manually.....	109
Table 40	4-1-4 Account Setting.....	110
Table 41	4-1-4 Login Error Notiifcation.....	111
Table 42	System Setting-Account Setting	112
Table 43	4-1-5 Web Server Setting	113
Table 44	4-1-5 Web Server Setting-Basic Setting.....	114
Table 45	4-1-5 Web Server Setting-Advanced Setting.....	114
Table 46	4-1-5 RESTful API-Request Method GET/Design	115
Table 47	4-1-5 RESTful API-Request Method PUT/Design.....	116
Table 48	4-1-5 RESTful API-Test Setting	116
Table 49	4-1-6 Firewall Setting.....	117
Table 50	4-1-7 Factory Default Settings of UA I/O Modules.....	119
Table 51	4-1-7 Update Firmware	121
Table 52	4-2-1 Function Overview	123
Table 53	4-2-1 Download the file from device	124
Table 54	4-2-2 I/O Setting-Digital Input.....	125
Table 55	4-2-2 I/O Setting-Digital Output.....	126
Table 56	4-2-2 I/O Setting-Analog Input	127
Table 57	4-2-2 I/O Setting-Analog Output	128
Table 58	4-2-3 Module Setting-Scaling	129
Table 59	4-2-4 I/O Status-Digital Input	130
Table 60	4-2-4 I/O Status-Digital Output	131
Table 61	4-2-4 I/O Status-Analog Input	132
Table 62	4-2-4 I/O Status-Analog Output	133
Table 63	4-3-1 Server Setting-Connection Settings	139
Table 64	4-3-2 Server Certificate	140
Table 65	4-3-3 Client Setting-Functional Status.....	141
Table 66	4-3-3 Client Setting-Connection Setting.....	141
Table 67	4-3-3 Client Setting-Connection Setting.....	142
Table 68	4-3-4 Client Certificate-Download the file from device	143
Table 69	4-4-1 MQTT Broker Connection Setting	144
Table 70	4-4-2 Client Setting-Content Setting	145
Table 71	4-4-2 JSON Format-Enable	146
Table 72	4-4-2 JSON Format-Not Enable	147

Table 73	4-4-3 Certificate-SSL/TLS is not enable.....	148
Table 74	4-4-3 One/Two-way Authentication Screen.....	149
Table 80	4-5-2 Rule Information Setting.....	151
Table 81	4-5-2 Rule Setting-Advanced Setting.....	151
Table 82	4-5-2-2 I/O Control	152
Table 83	4-5-2-2 I/O Control-Setting	153
Table 84	4-5-2-3 Schedule-Rule Setting List	154
Table 85	4-5-2-3 Schedule-Content Setting.....	154
Table 86	4-5-2-3 Schedule-Cycle/Specified Range/Exclude	155
Table 75	4-5-1 Event Log-Digital Input/Output	156
Table 76	4-5-1 Event Log-Analog Input/Output.....	157
Table 77	4-5-1 Event Log-Log File Download.....	158
Table 78	4-5-1-2 Line message sending test.....	159
Table 79	4-5-1-2 Send messages To Line – Event Log + Line Settings.....	160
Table 87	4-5-3 IoTstar Setting-Connection Setting	162
Table 88	4-5-4 EZ-UAQ Utility Settings	163
Table 89	5 Recovering Firmware Setting	165
Table 90	Appendix B. MQTT JSON Format of the UA I/O Series.....	167

1. UA I/O Introduction:

UA I/O series is a series of **IIoT I/O modules** known as **U-7500 or U-7000**. This series built-in provides the communication protocol functions of the Industrial Internet of Things (IIoT), including OPC UA Server / Client, MQTT Client and Restful API functions. It allows users to choose the network communication method according to their needs and directly transfer the value of the I/O channel to the Cloud system or the field-side control system for displaying, analysis or strategy.

1.1 Introduction

UA I/O modules is a series of Ethernet I/O modules that supports the **OPC UA Server / Client, MQTT Client and RESTful API** services (and can be used simultaneously). Users can choose the networking mode according to their needs and environment, to transmit the values of built-in I/O channels to the Cloud system or field control system for displaying, analysis or strategy. Support Scaling. Let the analog signal be converted into a more readable value. Support logic function rule setting IF, THEN, ELSE, can set up logical condition/action for I/O and virtual point; Provide schedule function to execute the set rules at a specific time; and support RESTful API function, can read/write I/O and virtual point through HTTP or HTTPS (identity verification and communication encryption).

In the information security and data security of the platform connection method, the following functions are provided respectively to enhance the security of I/O networking:

Table 1 1-1 Connectivity for various platforms

Connectivity for various platforms	OPC UA, MQTT, RESTful API can be used simultaneously
Connect to Cloud	MQTT
Connect to SCADA	OPC UA, MQTT
Connect to MES	OPC UA
Connect to IT	MQTT, RESTful API (HTTP, HTTPS)
Information Security	HTTPS, Port Binding, Allowlist, ICMP drop
Data Security	Certificate(X.509), Communication Encryption(SSL/TLS)

UA I/O Series provides a Web-based User Interface (Web UI) to configure the module, control the output channels, monitor the connection, and I/O status via a normal web browser. It is easy, fast, and no extra APP needed.

OPC UA Architecture:

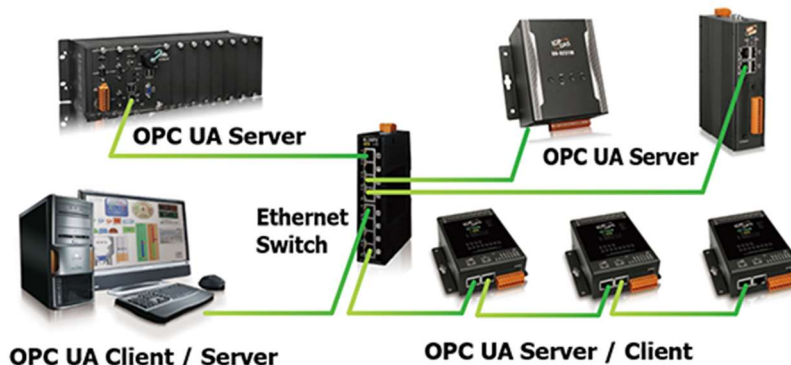

Figure 1 1-1 OPC UA Architecture

MQTT Architecture:

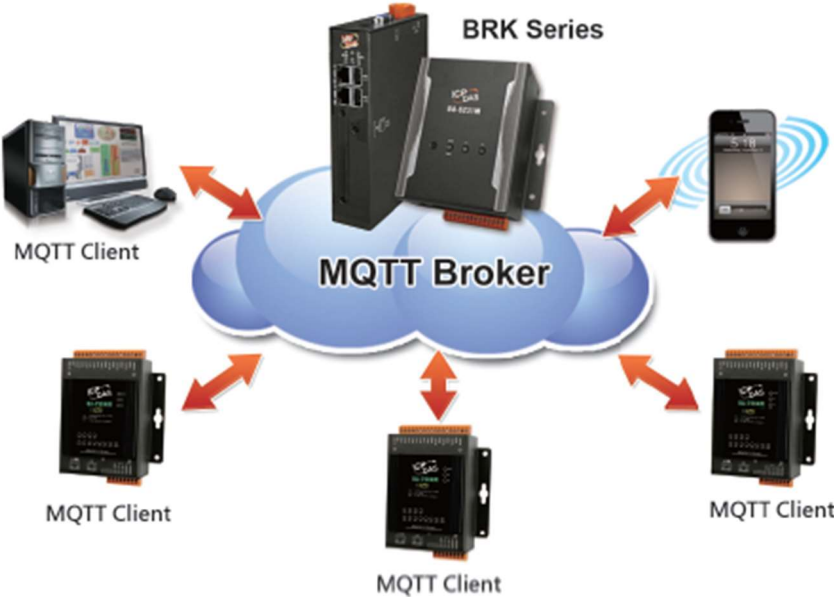

Figure 2 1-1 MQTT Architecture

1.2 Features

- Built-in OPC UA Server Service

Compliance with IEC 62541 Standard. Provides functions of Active Transmission, Transmission Security Encryption (SSL/TLS), User Authentication (X.509 Certificates / Account password), Communication Error Detection and Recovery, etc. to connect SCADA or OPC UA Clients. Recommend to keep the maximum number of sessions within 3 connections.
- Built-in OPC UA Client Service

Compliance with IEC 62541 Standard. Provides Transmission Security Encryption (SSL / TLS), User Authentication (X.509 Certificates / Account password), and OPC UA Server Connectivity.
- Built-in MQTT Client Service

Build-in MQTT Client Service (Compliance with MQTT V.3.1.1 protocol). Provides functions of IoT Active M2M Transmission, QoS (Quality of Service), Retains Mechanism, Identity Authentication, Encryption, Last Will, etc.
- Support RESTful API function

Support to read/write I/O and Virtual points via HTTP.
Provide high-security HTTPS (identity verification and communication encryption) to read/write I/O and Virtual points.
- Support to Execute OPC UA, MQTT, and RESTful API Communication at the Same Time.
- Support IoTstar Cloud Management Software

UA I/O factory version 9.7 and later supports this function.
- Support Scaling

AI/AO modules support Scaling. Let the analog signal be converted into a more readable value.
- Support logic function Rule Setting: IF, THEN, ELSE

Users can set up logical condition/action for I/O and virtual point.
- Support Schedule

Provide schedule function to execute the set rules at a specific time.
- Support Trigger Message

When the I/O value changes, record the message in a file (CSV) for easy device tracking.
When the I/O value changes, send the message to Line for easy device tracking.
- Built-in Web Server to Provide the Web User Interface

UA I/O Series provides a Web-based User Interface (Web UI) to configure the module, control the output channels, monitor the connection, and I/O status via a normal web browser. It is easy, fast,

and no extra APP needed.

■ **Diversified Choices**

Different models provide different AI, AO, DI, or DO channels, and users can choose the desired model according to the needs of the case.

■ **Dual-port Ethernet Switch for Daisy-Chain Topology**

Provide dual-port Ethernet switch for Daisy-Chain Topology. The cabling of Daisy-Chain Topology is much easier, and the total costs of cables and switches are significantly reduced.

■ **IEEE 802.3af-compliant Power over Ethernet (PoE)**

UA I/O follows IEEE 802.3af (classification, Class 2) compliant Power over Ethernet (PoE) specification. It allows receiving power from PoE enabled network by Ethernet pairs. This feature provides greater flexibility and efficiency to simplify system design, save space, and reduce wirings and power sockets.

1.3 Selection Guide

U-7500 Series UA I/O Selection Guide:

Table 2 1-3 U-7500 Series UA I/O Selection Guide

U-7500 Series OPC UA I/O Module Selection Guide								
Module	AI		AO		DI		DO	
	Ch.	Type	Ch.	Type	Ch.	Type	Ch.	Type
U-7502M	3	±150 mV, ±500 mV, ±1 V, ±5 V, ±10 V +0 mA ~ +20 mA, ±20 mA, 4 ~ 20 mA	-	-	6	Wet (Sink/Source)	3	Power Relay, Form A (SPST N.O.)
U-7504M	4	±500mV, ±1V, ±5V, ±10V, 0~20mA, ±20mA, 4~20mA	4	0~5V, ±5V, 0~10V, ±10V, 0~20mA, 4~20mA	4	Dry (Source), Wet (Sink)	-	-
U-7515M	7	Pt100, Pt1000, Ni120, Cu100, Cu1000	-	-	-	-	-	-
U-7517M	8	±150 mV, ±500 mV, ±1 V, ±5 V, ±10 V ±20 mA, 0 ~ 20 mA, 4 ~ 20 mA	-	-	-	-	4	Isolated Open Collector (Sink)
U-7517M-10	10 / 20	±150mV, ±500mV, ±1V, ±5V, ±10V, ±20mA, 0~20mA, 4~20mA	-	-	-	-	-	-
U-7518ZM/S	10	±15 mV, ±50 mV, ±100 mV, ±500 mV, ±1 V, ±2.5 V ±20 mA, 0 ~ 20 mA, 4 ~ 20 mA Thermocouple: J, K, T, E, R, S, B, N, C, L, M, LDIN43710	-	-	-	-	3	Isolated Open Collector (Sink)
U-7518ZM/S2								
U-7519ZM/S	10	±15mV, ±50mV, ±100mV, ±150mV, ±500mV, ±1V, ±2.5V, ±5V, ±10V, ±20mA, 0~20mA, 4~20mA Thermocouple: J, K, T, E, R, S, B, N, C, L, M, LDIN43710	-	-	-	-	3	Isolated Open Collector (Sink)
U-7519ZM/S2								
U-7524M	-	-	4	0~5V, ±5V, 0~10V, ±10V, 0~20mA, 4~20mA	5	Dry (Source) Wet (Sink)	5	Isolated Open Collector (Sink)
U-7526M	6	±500 mV, ±1V, ±5V, ±10V, 0~20mA, ±20mA, 4~20mA	2	0~5V, ±5V, 0~10V, ±10V, 0~20mA, 4~20mA	2	Dry (Source) Wet (Sink)	2	Isolated Open Collector (Sink)
U-7528M	-	-	8	0~5V, ±5V, 0~10V, ±10V, 0~20mA, 4~20mA	-	-	-	-

U-7500 Series OPC UA I/O Module Selection Guide								
Module	AI		AO		DI		DO	
	Ch.	Type	Ch.	Type	Ch.	Type	Ch.	Type
U-7542M	-	-	-	-	-	-	16	Isolated Open Collector (Sink)
U-7544M	-	-	-	-	8	Wet (Sink/Source)	8	Isolated Open Collector (Sink)
U-7545M	-	-	-	-	-	-	16	Isolated Open Collector (Source)
U-7550AM	-	-	-	-	12	Dry (Source) Wet (Sink)	6	Isolated Open Collector (Sink)
U-7551M	-	-	-	-	16	Wet (Sink/Source)	-	-
U-7552M	-	-	-	-	8	Wet (Sink/Source)	8	Isolated Open Collector (Source)
U-7553M	-	-	-	-	16	Dry (Source)	-	-
U-7555M	-	-	-	-	8	Dry (Source), Wet (Sink,Source)	8	Isolated Open Collector (Source)
U-7558M	-	-	-	-	8	Wet (Sink/Source)	-	-
U-7559M	-	-	-	-	8	Wet (Sink/Source)	-	-
U-7560M	-	-	-	-	6	Wet (Sink/Source)	6	Power Relay Form A (SPST N.O.)
U-7561M	-	-	-	-	-	-	11	Power Relay, Form A (SPST N.O.)
U-7567M	-	-	-	-	-	-	8	Power Relay, Form A (SPST N.O.)

1.4 Specifications

1.4.1 Software Specifications (Series Common)

Table 3 1-4-1 Software Specifications

UA I/O Software Specifications (Series Common)	
Protocol	
OPC UA Server / Client	<ul style="list-style-type: none"> ● OPC Unified Architecture: 1.02 ● Core Server Facet ● Data Access Server Facet ● Method Server Facet ● UA-TCP UA-SC UA Binary ● User Authentication: <ul style="list-style-type: none"> - Anonymous - Username/Password - X.509 Certificate ● Security Policy: <ul style="list-style-type: none"> - None - Basic128Rsa15 (Sign, Sign & Encrypt) - Basic256 (Sign, Sign & Encrypt) - Basic256Sha256 (Sign, Sign and Encrypt) - Aes128Sha256RsaOaep (Sign, Sign & Encrypt) - Aes256Sha256RsaPss (Sign, Sign & Encrypt) ● Can Execute with MQTT and RESTful API Communication Simultaneously ● Max. Session Connections: 3 (Server only)
MQTT Client	<ul style="list-style-type: none"> ● Connect to the MQTT Broker to read or control the I/O channel value by the publish/subscribe messaging mechanism. (MQTT Ver. 3.1.1; TLS Ver. 1.2)
RESTful API	<ul style="list-style-type: none"> ● User can read/write the I/O & Virtual points through HTTP or HTTPS.
Function	
Web Interface for Configuration	<ul style="list-style-type: none"> ● The system operation can be performed through the browser without installing software tools. ● Use AES 256 encryption algorithm to encrypt web page setting data for general communication. ● HTTPS upgrades the security of web communication.
Scaling	<ul style="list-style-type: none"> ● Convert the analog signal to a more readable value. ● Function is only available for modules with AI/AO.
Security	<ul style="list-style-type: none"> ● Information Security: Provide HTTPS, Port Binding, Allowlist, ICMP drop functions. ● Data security: Provide Certificate (X.509), Communication Encryption (SSL/TLS) functions.
Rule Setting	<ul style="list-style-type: none"> ● Provide simple logic condition rule setting, let UA I/O do automatic condition judgment and action control, to achieve simple intelligentization.
Schedule	<ul style="list-style-type: none"> ● Provide schedule function to execute the set rules at a specific time.
Event Log	<ul style="list-style-type: none"> ● When the I/O value changes, record the current I/O value for easy device tracking in the future.
IoTstar Setting	<ul style="list-style-type: none"> ● Support IoTstar cloud management software developed by ICP DAS.

1.4.2 U-7502M Specifications

Table 4 1-4-2 U-7502M Specifications

System Specifications

CPU Module	
CPU	32-bit CPU (400 MHz)
Watchdog Timer	Module, Communication(Programmable)
Isolation	
2-way Isolation	I/O: 2500 VDC
EMS Protection	
ESD (IEC 61000-4-2)	±4 kV Contact for each terminal ±8 kV Air for random point
EFT (IEC 61000-4-4)	±2 kV for Power Line
Surge (IEC 61000-4-5)	±2 kV for Power Line
LED Indicators	
Status	Run, Ethernet, I/O
Ethernet	
Ports	2 x RJ-45, 10/100 Base-TX, Switch Ports
PoE	Yes
LAN bypass	Yes
Security	ID, Password and IP Filter

Power	
Reverse Polarity Protection	Yes
Consumption	4.1 W
Powered from PoE	IEEE 802.3af, Class2
Powered from Terminal Block	+12 to +48 VDC
Mechanical	
Dimensions (mm)	97 x 120 x 47 (W x L x H)
Installation	DIN-Rail mounting
Environment	
Operating Temperature	-25 °C ~ +75 °C
Storage Temperature	-30 °C ~ +80 °C
Humidity	10 ~ 90% RH, Non-condensing

I/O Specifications

Analog Input	
Channels	3 (Differential)
Type	Voltage, Current
Range	±150 mV, ±500 mV, ±1 V, ±5 V, ±10 V 0 to 20 mA, ±20 mA, 4 to 20 mA(Jumper Selectable)
Resolution	16-bit
Accuracy	Normal Mode: ±0.1% Fast Mode: ±0.5% or better
Sampling Rate	Normal Mode: 10 samples/second (Total) Fast Mode: 50 samples/second (Total)
Input Impedance	Voltage: 2 MΩ Current: 125 Ω
Common Mode Rejection	86 dB (min.)
Normal Mode Rejection	100 dB
Overvoltage Protection	240 Vrms
Overcurrent Protection	50 mA at 110 VDC (max.)
Individual Channel Configuration	Yes
Open Wire Detection	Yes
Zero Drift	±20 μV/°C
Span Drift	±25 ppm/°C
Isolation	±400 VDC, Virtual Channel to Channel Isolation

Digital Input/Counter	
Channels	6
Type	Wet Contact
Sink/Source (NPN/PNP)	Sink/Source
ON Voltage Level	+10 ~ +50 VDC
OFF Voltage Level	+4 VDC (max.)
Max. Counts	4,294,967,295 (32-bit)
Frequency	100 Hz
Min. Pulse Width	5 ms
Input Impedance	10 kΩ, 0.5W
Overvoltage Protection	+70 VDC

Relay Output	
Channels	3
Type	Power Relay, Form A (SPST N.O.)
Contact Rating	5 A @ 250 VAC/24 VDC (Resistive Load)
Operate Time	6 ms (Typical)
Release Time	3 ms (Typical)
Electrical Endurance	10 ⁵ ops.
Mechanical Endurance	2 × 10 ⁷ ops.
Power on Value	Programmable
Safe Value	Programmable

I/O Specifications

Analog Input	
Channels	
Type	
Range	
Resolution	
Accuracy	
Sampling Rate	
Input Impedance	
Common Mode Rejection	
Normal Mode Rejection	
Overvoltage Protection	
Overcurrent Protection	
Individual Channel Configuration	
Open Wire Detection	
Zero Drift	
Span Drift	
Isolation	

1.4.3 U-7504M Specifications

Table 5 1-4-3 U-7504M Specifications

System Specifications

CPU Module	
CPU	32-bit CPU (400 MHz)
Watchdog Timer	Module, Communication (Programmable)
Isolation	
2-way Isolation	I/O: 2500 VDC
EMS Protection	
EFT (IEC 61000-4-4)	±2 kV for Power Line
ESD (IEC 61000-4-2)	±4 kV Contact for each terminal ±8 kV Air for random point
Surge (IEC 61000-4-5)	±2 kV for Power Line
LED Indicators	
Status	Run, Ethernet, I/O
Ethernet	
Ports	2 x RJ-45, 10/100 Base-TX, Switch Ports
PoE	Yes
LAN bypass	Yes
Security	ID, Password and IP Filter

Power	
Reverse Polarity Protection	Yes
Consumption	5.5 W
Powered from PoE	IEEE 802.3af, Class2
Powered from Terminal Block	+12 ~ +48 VDC
Mechanical	
Dimensions (mm)	97 x 120 x 47 (W x L x H)
Installation	DIN-Rail mounting
Environment	
Operating Temperature	-25 °C ~ +75 °C
Storage Temperature	-30 °C ~ +80 °C
Humidity	10 ~ 90% RH, Non-condensing

I/O Specifications

Analog Input	
Channels	4 (Differential)
Type	Voltage, Current
Range	±500 mV, ±1 V, ±5 V, ±10 V 0 to 20 mA, ±20 mA, 4 to 20 mA (Jumper Selectable)
Resolution	16-bit
Accuracy	Normal Mode: ±0.1% Fast Mode: ±0.5% or better
Sampling Rate	Normal Mode: 10 samples/second (Total) Fast Mode: 50 samples/second (Total)
Input Impedance	Voltage: 2 MΩ Current: 125 Ω
Common Mode Rejection	86 dB (min.)
Normal Mode Rejection	100 dB
Common Voltage Protection	±200 VDC
Overvoltage Protection	240 Vrms
Overcurrent Protection	50 mA at 110 VDC (max.)
Individual Channel Configuration	Yes
Open Wire Detection	Yes
Zero Drift	±20 µV/°C
Span Drift	±25 ppm/°C
Isolation	±400 VDC, Virtual Channel to Channel Isolation

Analog Output	
Channels	4
Type	Voltage, Current
Range	+0 to +5 VDC, ±5 VDC, +0 to +10 VDC, ±10 VDC, 0 to 20 mA, 4 to 20 mA (Jumper Selectable)
Resolution	12-bit
Accuracy	±0.1% of FSR
Open Wire Detection	For 4 ~ 20 mA only
Voltage Output Capability	10 V @ 20 mA
Current Load Resistance	400 Ω
Individual Channel Configuration	Yes
Power-on Value	Programmable
Safe Value	Programmable

Digital Input/Counter	
Channels	4
Type	Dry Contact Wet Contact
ON Voltage Level	Dry: Open Wet: +1 VDC (max.)
OFF Voltage Level	Dry: Close to GND Wet: +3.5 to +30 VDC
Max. Count	4,294,967,295 (32-bit)
Frequency	100 Hz
Min. Pulse Width	5 ms
Effective Distance	500m (max.)
Overvoltage Protection	+30 VDC

1.4.4 U-7515M Specifications

Table 6 1-4-4 U-7515M Specifications

System Specifications

CPU Module	
CPU	32-bit CPU (400 MHz)
Watchdog Timer	Module, Communication(Programmable)
Isolation	
2-way Isolation	I/O: 3000 VDC
EMS Protection	
ESD (IEC 61000-4-2)	±4 kV Contact for each terminal ±8 kV Air for random point
EFT (IEC 61000-4-4)	±2 kV for Power Line
Surge (IEC 61000-4-5)	±2 kV for Power Line
LED Indicators	
Status	Run, Ethernet, I/O
Ethernet	
Ports	2 x RJ-45, 10/100 Base-TX, Swtich Ports
PoE	Yes
LAN bypass	Yes
Security	ID, Password and IP Filter
Power	
Reverse Polarity Protection	Yes
Consumption	3.2 W
Powered from PoE	IEEE 802.3af, Class2
Powered from Terminal Block	+12 ~ +48 VDC
Mechanical	
Dimensions (mm)	97 x 120 x 47 (W x L x H)
Installation	DIN-Rail mounting
Environment	
Operating Temperature	-25 °C ~ +75 °C
Storage Temperature	-30 °C ~ +80 °C
Humidity	10 ~ 90% RH, Non-condensing

I/O Specifications

Analog Input	
Channels	7 (Differential)
Type	RTD (2-wire, 3-wire)
Sensor Type	Pt100, Pt1000, Ni120, Cu100, Cu1000
Resistance Measurement	3.2 kΩ (max.)
Resolution	16-bit
Accuracy	±0.05%
Sampling Rate	12 samples/second (Total)
Input Impedance	> 1 MΩ
Common Mode Rejection	150 dB
Normal Mode Rejection	100 dB
Overvoltage Protection	+120 VDC
Individual Channel Configuration	Yes
Open Wire Detection	Yes
3-wire RTD Lead Resistance Elimination	Yes
Zero Drift	±0.5 μV/°C
Span Drift	±20 μV/°C

1.4.5 U-7517M Specifications

Table 7 1-4-5 U-7517M Specifications

System Specifications

CPU Module	
CPU	32-bit CPU (400 MHz)
Watchdog Timer	Module, Communication(Programmable)
Isolation	
2-way Isolation	I/O: 2500 VDC
EMS Protection	
ESD (IEC 61000-4-2)	±4 kV Contact for each terminal ±8 kV Air for random point
EFT (IEC 61000-4-4)	±2 kV for Power Line
Surge (IEC 61000-4-5)	±2 kV for Power Line
LED Indicators	
Status	Run, Ethernet, I/O
Ethernet	
Ports	2 x RJ-45, 10/100 Base-TX, Switch Ports
PoE	Yes
LAN bypass	Yes
Security	ID, Password and IP Filter
Power	
Reverse Polarity Protection	Yes
Consumption	4.4 W
Powered from PoE	IEEE 802.3af, Class2
Powered from Terminal Block	+12 ~ +48 VDC
Mechanical	
Dimensions (mm)	97 x 120 x 47 (W x L x H)
Installation	DIN-Rail mounting
Environment	
Operating Temperature	-25 °C ~ +75 °C
Storage Temperature	-30 °C ~ +80 °C
Humidity	10 ~ 90% RH, Non-condensing

I/O Specifications

Analog Input	
Channels	8 (Differential)
Type	Voltage, Current
Range	±150 mV, ±500 mV, ±1 V, ±5 V, ±10 V ±20 mA, 0 to 20 mA, 4 to 20 mA (Jumper Selectable)
Resolution	16-bit
Accuracy	Normal Mode: ±0.1% Fast Mode: ±0.5% or better
Sampling Rate	Normal Mode: 10 samples/second (Total) Fast Mode: 50 samples/second (Total)
Input Impedance	Voltage: 2 MΩ Current: 125 Ω
Common Mode Rejection	86 dB (min.)
Normal Mode Rejection	100 dB
Common Voltage Protection	±200 VDC
Overvoltage Protection	240 Vrms
Overcurrent Protection	50 mA at 110 VDC (max.)
Individual Channel Configuration	Yes
Open Wire Detection	For 4 ~ 20 mA only
Zero Drift	±20 μV/°C
Span Drift	±25 ppm/°C
Isolation	±400 VDC, Virtual Channel to Channel Isolation
Digital Output	
Channels	4
Type	Isolated Open Collector
Sink/Source (NPN/PNP)	Sink
Load Voltage	+5 ~ +50 VDC
Load Current	700 mA/channel
Overvoltage Protection	+60 VDC
Overload Protection	1.4 A
Short-circuit Protection	Yes
Power on Value	Programmable
Safe Value	Programmable

1.4.6 U-7517M-10 Specifications

Table 8 1-4-6 U-7517M-10 Specifications

System Specifications

CPU Module	
CPU	32-bit CPU (400 MHz)
Watchdog Timer	Module, Communication (Programmable)
Isolation	
2-way Isolation	I/O: 2500 VDC
EMS Protection	
ESD (IEC 61000-4-2)	±4 kV Contact for each terminal ±8 kV Air for random point
EFT (IEC 61000-4-4)	±2 kV for Power Line
Surge (IEC 61000-4-5)	±2 kV for Power Line
LED Indicators	
Status	Run, Ethernet, I/O
Ethernet	
Ports	2 x RJ-45, 10/100 Base-TX, Switch Ports
PoE	Yes
LAN bypass	Yes
Security	ID, Password and IP Filter
Power	
Reverse Polarity Protection	Yes
Consumption	3.8 W
Powered from PoE	IEEE 802.3af, Class2
Powered from Terminal Block	+12 ~ +48 VDC
Mechanical	
Dimensions (mm)	97 x 120 x 47 (W x L x H)
Installation	DIN-Rail mounting
Environment	
Operating Temperature	-25 °C ~ +75 °C
Storage Temperature	-30 °C ~ +80 °C
Humidity	10 ~ 90% RH, Non-condensing

I/O Specifications

Analog Input	
Channels	10 differential or 20 single-ended (Note1), software selectable
Type	Voltage, Current
Range	±150 mV, ±500 mV, ±1 V, ±5 V, ±10 V, ±20 mA, 0 to 20 mA, 4 to 20 mA (Jumper Selectable)
Resolution	16-bit
Accuracy	Normal Mode: ±0.1% Fast Mode: ±0.5% or better
Sampling Rate	Normal Mode: 10 samples/second (Total) Fast Mode: 50 samples/second (Total)
Input Impedance	Voltage: 2 MΩ (Differential), 1 MΩ (Single-ended) Current: 125 Ω
Common Mode Rejection	86 dB (min.)
Normal Mode Rejection	100 dB
Common Voltage Protection	±200 VDC
Overvoltage Protection	Differential: 240 Vrms Single-ended: 150 Vrms
Overcurrent Protection	50 mA at 110 VDC (max.)
Individual Channel Configuration	Yes
Open Wire Detection	For 4 ~ 20 mA only
Zero Drift	±20 μV/°C
Span Drift	±25 ppm/°C
Isolation	±400 VDC, Virtual Channel to Channel Isolation

1.4.7 U-7518ZM/S, U-7518ZM/S2 Specifications

Table 9 1-4-7 U-7518ZM/S, U-7518ZM/S2 Specifications

System Specifications

CPU Module	
CPU	32-bit CPU (400 MHz)
Watchdog Timer	Module, Communication (Programmable)
Isolation	
2-way Isolation	I/O: 2500 VDC
EMS Protection	
ESD (IEC 61000-4-2)	±4 kV Contact for each terminal ±8 kV Air for random point
EFT (IEC 61000-4-4)	±4 kV for Power Line
LED Indicators	
Status	Run, Ethernet, I/O
Ethernet	
Ports	RJ-45 x 2, 10/100 Base-TX, Swtich Ports
PoE	Yes
LAN bypass	Yes
Security	ID, Password and IP Filter
Power	
Reverse Polarity Protection	Yes
Consumption	3.3 W
Powered from PoE	IEEE 802.3af, Class2
Powered from Terminal Block	+12 ~ +48 VDC
Mechanical	
Dimensions (mm)	97 x 114 x 47 (W x L x H)
Installation	DIN-Rail mounting
Environment	
Operating Temperature	-25 °C ~ +75 °C
Storage Temperature	-30 °C ~ +80 °C
Humidity	10 ~ 90% RH, Non-condensing

I/O Specifications

Analog Input	
Channels	10 (Differential)
Type	Voltage, Current, Thermocouple
Temperature Output Consistency	Yes
Stable Temperature Output in the Field	Yes
Range	±15 mV, ±50 mV, ±100 mV, ±500 mV, ±1 V, ±2.5 V ±20 mA, 0 to 20 mA, 4 to 20 mA (Requires Optional External 125 Ω Resistor) Thermocouple (J, K, T, E, R, S, B, N, C, L, M, and LDIN43710)
Resolution	16-bit
Accuracy	±0.1% of FSR or better
Sampling Rate	10 Samples/Second (Total)
Input Impedance	> 300 kΩ
Common Mode Rejection	150 dB (min.)
Normal Mode Rejection	100 dB
Overvoltage Protection	240 Vrms
Individual Channel Configuration	Yes
Open Wire Detection	Yes
Zero Drift	±0.5 μV/°C
Span Drift	±25 ppm/°C
Isolation	±400 VDC, Virtual Channel to Channel Isolation

Digital Output	
Channels	3
Type	Isolated Open Collector
Sink/Source (NPN/PNP)	Sink
Load Voltage	+5 ~ +50 VDC
Load Current	700 mA/channel
Overvoltage Protection	+60 VDC
Overload Protection	1.4 A
Short-circuit Protection	Yes
Power on Value	Programmable
Safe Value	Programmable

1.4.8 U-7519ZM/S, U-7519ZM/S2 Specifications

Table 10 1-4-8 U-7519ZM/S, U-7519ZM/S2 Specifications

System Specifications

CPU Module	
CPU	32-bit CPU (400 MHz)
Watchdog Timer	Module, Communication (Programmable)
Isolation	
2-way Isolation	I/O: 2500 VDC
EMS Protection	
ESD (IEC 61000-4-2)	±4 kV Contact for each terminal ±8 kV Air for random point
EFT (IEC 61000-4-4)	±4 kV for Power Line
LED Indicators	
Status	Run, Ethernet, I/O
Ethernet	
Ports	2 x RJ-45, 10/100 Base-TX, Switch Ports
PoE	Yes
LAN bypass	Yes
Security	ID, Password and IP Filter
Power	
Reverse Polarity Protection	Yes
Consumption	3.6 W
Powered from PoE	IEEE 802.3af, Class2
Powered from Terminal Block	+12 ~ +48 VDC
Mechanical	
Dimensions (mm)	97 x 114 x 47 (W x L x H)
Installation	DIN-Rail mounting
Environment	
Operating Temperature	-25 °C ~ +75 °C
Storage Temperature	-30 °C ~ +80 °C
Humidity	10 ~ 90% RH, Non-condensing

I/O Specifications

Analog Input	
Channels	10 (Differential)
Type	Voltage, Current, Thermocouple
Temperature Output Consistency	Yes
Stable Temperature Output in the Field	Yes
Range	±15 mV, ±50 mV, ±100 mV, ±150 mV, ±500 mV, ±1 V, ±2.5 V, ±5 V, ±10 V ±20 mA, 0 to 20 mA, 4 to 20 mA (Requires Optional External 125 Ω Resistor) Thermocouple (J, K, T, E, R, S, B, N, C, L, M, and LDIN43710)
Resolution	16-bit
Accuracy	±0.1% of FSR or better
Sampling Rate	10 Samples/Second (Total)
Input Impedance	> 300 kΩ
Common Mode Rejection	86 dB (min.)
Normal Mode Rejection	100 dB
Overvoltage Protection	240 Vrms
Individual Channel Configuration	Yes
Open Wire Detection	Yes
Zero Drift	±0.5 μV/°C
Span Drift	±25 ppm/°C
Isolation	±400 VDC, Virtual Channel to Channel Isolation
Digital Output	
Channels	3
Type	Isolated Open Collector
Sink/Source (NPN/PNP)	Sink
Load Voltage	+5 ~ +50 VDC
Load Current	700 mA/channel
Overvoltage Protection	+60 VDC
Overload Protection	1.4 A
Short-circuit Protection	Yes
Power on Value	Programmable
Safe Value	Programmable

1.4.9 U-7524M Specifications

Table 11 1-4-9 U-7524M Specifications

System Specifications

CPU Module	
CPU	32-bit CPU (400 MHz)
Watchdog Timer	Module, Communication(Programmable)
Isolation	
2-way Isolation	I/O: 2500 VDC
EMS Protection	
ESD (IEC 61000-4-2)	±4 kV Contact for each terminal ±8 kV Air for random point
EFT (IEC 61000-4-4)	±4 kV for Power Line
Surge (IEC 61000-4-5)	±2 kV for Power Line
LED Indicators	
Status	Run, Ethernet, I/O
Ethernet	
Ports	2 x RJ-45, 10/100 Base-TX, Switch Ports
PoE	Yes
LAN bypass	Yes
Security	ID, Password and IP Filter

Power	
Reverse Polarity Protection	Yes
Consumption	5.5 W
Powered from PoE	IEEE 802.3af, Class2
Powered from Terminal Block	+12 ~ +48 VDC
Mechanical	
Dimensions (mm)	97 x 120 x 47 (W x L x H)
Installation	DIN-Rail mounting
Environment	
Operating Temperature	-25 °C ~ +75 °C
Storage Temperature	-30 °C ~ +80 °C
Humidity	10 ~ 90% RH, Non-condensing

I/O Specifications

Analog Output	
Channels	4
Type	Voltage, Current
Range	+0 to +5 VDC, ±5 VDC, +0 to +10 VDC, ±10 VDC, 0 to 20 mA, 4 to 20 mA (Jumper Selectable)
Resolution	12-bit
Accuracy	±0.1% of FSR
Open Wire Detection	For 4 ~ 20 mA only
Voltage Output Capability	10 V @ 20 mA
Current Load Resistance	500 Ω
Individual Channel Configuration	Yes
Power-on Value	Programmable
Safe Value	Programmable

Digital Input/Counter	
Channels	5
Type	Dry Contact, Wet Contact
ON Voltage Level	Dry: Close to GND Wet: +1 VDC (max.)
OFF Voltage Level	Dry: Open Wet: +3.5 ~ +30 VDC
Max. Counts	4,294,967,295 (32-bit)
Frequency	100 Hz
Min. Pulse Width	5 ms
Effective Distance	500m (max.)
Overvoltage Protection	+30 VDC
Digital Output	
Channels	5
Type	Isolated Open Collector
Sink/Source (NPN/PNP)	Sink
Load Voltage	+5 ~ +50 VDC
Load Current	600 mA/channel
Overvoltage Protection	+60 VDC
Overload Protection	1.4 A
Short-circuit Protection	Yes
Power on Value	Programmable
Safe Value	Programmable

1.4.10 U-7526M Specifications

Table 12 1-4-10 U-7526M Specifications

System Specifications

CPU Module	
CPU	32-bit CPU (400 MHz)
Watchdog Timer	Module, Communication (Programmable)
Isolation	
2-way Isolation	I/O: 2500 VDC
EMS Protection	
EFT (IEC 61000-4-4)	±2 kV for Power Line
ESD (IEC 61000-4-2)	±4 kV Contact for each terminal ±8 kV Air for random point
Surge (IEC 61000-4-5)	±2 kV for Power Line
LED Indicators	
Status	Run, Ethernet, I/O
Ethernet	
Ports	2 x RJ-45, 10/100 Base-TX, Switch Ports
PoE	Yes
LAN bypass	Yes
Security	ID, Password and IP Filter

Power	
Reverse Polarity Protection	Yes
Consumption	5.2 W
Powered from PoE	IEEE 802.3af, Class2
Powered from Terminal Block	+12 ~ +48 VDC
Mechanical	
Dimensions (mm)	97 x 120 x 47 (W x L x H)
Installation	DIN-Rail mounting
Environment	
Operating Temperature	-25 °C ~ +75 °C
Storage Temperature	-30 °C ~ +80 °C
Humidity	10 ~ 90% RH, Non-condensing

I/O Specifications

Analog Input	
Channels	6 (Differential)
Type	Voltage, Current
Range	±500 mV, ±1V, ±5 V, ±10 V 0 to 20 mA, ±20 mA, 4 to 20 mA (Jumper Selectable)
Resolution	16-bit
Accuracy	Normal Mode: ±0.1% Fast Mode: ±0.5% or better
Sampling Rate	Normal Mode: 10 samples/second (Total) Fast Mode: 50 samples/second (Total)
Input Impedance	Voltage: 2 MΩ Current: 125 Ω
Common Mode Rejection	86 dB (min.)
Normal Mode Rejection	100 dB
Common Voltage Protection	±200 VDC
Overvoltage Protection	240 Vrms
Overcurrent Protection	50 mA at 110 VDC (max.)
Individual Channel Configuration	Yes
Open Wire Detection	For 4 ~ 20 mA only
Zero Drift	±20 μV/°C
Span Drift	±25 ppm/°C
Isolation	±400 VDC, Virtual Channel to Channel Isolation
Analog Output	
Channels	2
Type	Voltage, Current
Range	+0 to +5 VDC, ±5 VDC, +0 to +10 VDC, ±10 VDC, 0 to 20 mA, 4 to 20 mA (Jumper Selectable)
Resolution	12-bit
Accuracy	±0.1% of FSR

Open Wire Detection	For 4 ~ 20 mA only
Voltage Output Capability	10 V @ 20 mA
Current Load Resistance	500 Ω
Individual Channel Configuration	Yes
Power-on Value	Programmable
Safe Value	Programmable

Digital Input/Counter	
Channels	2
Type	Dry Contact Wet Contact
ON Voltage Level	Dry: Close to GND Wet: +1 VDC (max.)
OFF Voltage Level	Dry: Open Wet: +3.5 to +30 VDC
Max. Counts	4,294,967,295 (32-bit)
Frequency	100 Hz
Min. Pulse Width	5 ms
Effective Distance	500m (max.)
Overvoltage Protection	+30 VDC
Digital Output	
Channels	2
Type	Isolated Open Collector
Sink/Source (NPN/PNP)	Sink
Load Voltage	+5 ~ +50 VDC
Load Current	700 mA/channel
Overvoltage Protection	+60 VDC
Overload Protection	1.4 A
Short-circuit Protection	Yes
Power-on Value	Programmable
Safe Value	Programmable

1.4.11 U-7528M Specifications

Table 13 1-4-11 U-7528M Specifications

System Specifications

CPU Module	
CPU	32-bit CPU (400 MHz)
Watchdog Timer	Module, Communication(Programmable)
Isolation	
2-way Isolation	I/O: 2500 VDC
EMS Protection	
ESD (IEC 61000-4-2)	±4 kV Contact for each terminal ±8 kV Air for random point
EFT (IEC 61000-4-4)	±4 kV for Power Line
LED Indicators	
Status	Run, Ethernet, I/O
Ethernet	
Ports	2 x RJ-45, 10/100 Base-TX, Switch Ports
PoE	Yes
LAN bypass	Yes
Security	ID, Password and IP Filter
Power	
Reverse Polarity Protection	Yes
Consumption	6.0 W
Powered from PoE	IEEE 802.3af, Class2
Powered from Terminal Block	+12 ~ +48 VDC
Mechanical	
Dimensions (mm)	97 x 120 x 47 (W x L x H)
Installation	DIN-Rail mounting
Environment	
Operating Temperature	-25 °C ~ +75 °C
Storage Temperature	-30 °C ~ +80 °C
Humidity	10 ~ 90% RH, Non-condensing

I/O Specifications

Analog Output	
Channels	8
Type	Voltage, Current
Range	+0 to +5 VDC, ±5 VDC, +0 to +10 VDC, ±10 VDC, 0 to 20 mA, 4 to 20 mA (Jumper Selectable)
Resolution	12-bit
Accuracy	±0.1% of FSR
Open Wire Detection	For 4 ~ 20 mA only
Voltage Output Capability	10 V @ 10 mA
Current Load Resistance	500 Ω
Individual Channel Configuration	Yes
Power-on Value	Programmable
Safe Value	Programmable

1.4.12 U-7542M Specifications

Table 14 1-4-12 U-7542M Specifications

System Specifications

CPU Module	
CPU	32-bit CPU (400 MHz)
Watchdog Timer	Module, Communication(Programmable)
Isolation	
2-way Isolation	I/O: 3750 VDC
EMS Protection	
ESD (IEC 61000-4-2)	±4 kV Contact for each terminal ±8 kV Air for random point
EFT (IEC 61000-4-4)	±4 kV for Power Line
Surge (IEC 61000-4-5)	±2 kV for Power Line
LED Indicators	
Status	Run, Ethernet, I/O
Ethernet	
Ports	2 x RJ-45, 10/100 Base-TX, Swtich Ports
PoE	Yes
LAN bypass	Yes
Security	ID, Password and IP Filter
Power	
Reverse Polarity Protection	Yes
Consumption	3.4 W
Powered from PoE	IEEE 802.3af, Class2
Powered from Terminal Block	+12 ~ +48 VDC
Mechanical	
Dimensions (mm)	97 x 120 x 47 (W x L x H)
Installation	DIN-Rail mounting
Environment	
Operating Temperature	-25 °C ~ +75 °C
Storage Temperature	-30 °C ~ +80 °C
Humidity	10 ~ 90% RH, Non-condensing

I/O Specifications

Digital Output	
Channels	16
Type	Isolated Open Collector
Sink/Source (NPN/PNP)	Sink
Load Voltage	+ 3.5 ~ + 50 VDC
Load Current	650 mA/channel at 25°C Direct Drive Power Relay Module
Overvoltage Protection	+60 VDC
Overload Protection	1.3 A
Short-circuit Protection	Yes
Power-on Value	Programmable
Safe Value	Programmable

1.4.13 U-7544M Specifications

Table 15 1-4-13 U-7544M Specifications

System Specifications

CPU Module	
CPU	32-bit CPU (400 MHz)
Watchdog Timer	Module, Communication(Programmable)
Isolation	
2-way Isolation	I/O: 2500 VDC
EMS Protection	
ESD (IEC 61000-4-2)	±4 kV Contact for each terminal ±8 kV Air for random point
EFT (IEC 61000-4-4)	±4 kV for Power Line
LED Indicators	
Status	Run, Ethernet, I/O
Ethernet	
Ports	2 x RJ-45, 10/100 Base-TX, Swtich Ports
PoE	Yes
LAN bypass	Yes
Security	ID, Password and IP Filter
Power	
Reverse Polarity Protection	Yes
Consumption	3.5 W
Powered from PoE	IEEE 802.3af, Class2
Powered from Terminal Block	+12 ~ +48 VDC
Mechanical	
Dimensions (mm)	97 x 120 x 47 (W x L x H)
Installation	DIN-Rail mounting
Environment	
Operating Temperature	-25 °C ~ +75 °C
Storage Temperature	-30 °C ~ +80 °C
Humidity	10 ~ 90% RH, Non-condensing

I/O Specifications

Digital Input/Counter	
Channels	8
Type	Wet Contact
Sink/Source (NPN/PNP)	Sink/Source
ON Voltage Level	+10 ~ +50 VDC
OFF Voltage Level	+4 VDC (max.)
Max. Counts	4,294,967,295 (32-bit)
Frequency	100 Hz
Min. Pulse Width	5 ms
Input Impedance	10 kΩ
Overvoltage Protection	+70 VDC
Digital Output	
Channels	8
Type	Isolated Open Collector
Sink/Source (NPN/PNP)	Sink
Load Voltage	+ 3.5 ~ + 50 VDC
Load Current	650 mA/channel at 25°C Direct Drive Power Relay Module
Overvoltage Protection	+60 VDC
Overload Protection	1.4 A
Short-circuit Protection	Yes
Power on Value	Programmable
Safe Value	Programmable

1.4.14 U-7545M Specifications

Table 16 1-4-14 U-7545M Specifications

System Specifications

CPU Module	
CPU	32-bit CPU (400 MHz)
Watchdog Timer	Module, Communication(Programmable)
Isolation	
2-way Isolation	I/O: 3750 VDC
EMS Protection	
ESD (IEC 61000-4-2)	±4 kV Contact for each terminal ±8 kV Air for random point
EFT (IEC 61000-4-4)	±4 kV for Power Line
Surge (IEC 61000-4-5)	±2 kV for Power Line
LED Indicators	
Status	Run, Ethernet, I/O
Ethernet	
Ports	2 x RJ-45, 10/100 Base-TX, Swtich Ports
PoE	Yes
LAN bypass	Yes
Security	ID, Password and IP Filter
Power	
Reverse Polarity Protection	Yes
Consumption	3.1 W
Powered from PoE	IEEE 802.3af, Class2
Powered from Terminal Block	+12 ~ +48 VDC
Mechanical	
Dimensions (mm)	97 x 120 x 47 (W x L x H)
Installation	DIN-Rail mounting
Environment	
Operating Temperature	-25 °C ~ +75 °C
Storage Temperature	-30 °C ~ +80 °C
Humidity	10 ~ 90% RH, Non-condensing

I/O Specifications

Digital Output	
Channels	16
Type	Isolated Open Source
Sink/Source (NPN/PNP)	Source
Load Voltage	+10 ~ +40 VDC
Load Current	600 mA/channel
Overvoltage Protection	+47 VDC
Overload Protection	1.4 A (with short-circuit protection)
Short-circuit Protection	Yes
Power on Value	Programmable
Safe Value	Programmable

1.4.15 U-7550AM Specifications

Table 17 1-4-15 U-7550AM Specifications

System Specifications

CPU Module	
CPU	32-bit CPU (400 MHz)
Watchdog Timer	Module, Communication(Programmable)
Isolation	
2-way Isolation	I/O: 2500 VDC
EMS Protection	
ESD (IEC 61000-4-2)	±4 kV Contact for each terminal ±8 kV Air for random point
EFT (IEC 61000-4-4)	±4 kV for Power Line
LED Indicators	
Status	Run, Ethernet, I/O
Ethernet	
Ports	2 x RJ-45, 10/100 Base-TX, Switch Ports
PoE	Yes
LAN bypass	Yes
Security	ID, Password and IP Filter
Power	
Reverse Polarity Protection	Yes
Consumption	2.9 W
Powered from PoE	IEEE 802.3af, Class2
Powered from Terminal Block	+12 ~ +48 VDC
Mechanical	
Dimensions (mm)	97 x 120 x 47 (W x L x H)
Installation	DIN-Rail mounting
Environment	
Operating Temperature	-25 °C ~ +75 °C
Storage Temperature	-30 °C ~ +80 °C
Humidity	10 ~ 90% RH, Non-condensing

I/O Specifications

Digital Input/Counter	
Channels	12
Type	Dry Contact, Wet Contact
Sink/Source (NPN/PNP)	Dry: Source Wet: Sink
ON Voltage Level	Dry: Close to GND Wet: 1 VDC (max.)
OFF Voltage Level	Dry: Open Wet: +3.5 ~ +50 VDC (max.)
Max. Counts	4,294,967,295 (32-bit)
Frequency	100 Hz
Min. Pulse Width	5 ms
Input Impedance	10 kΩ
Overvoltage Protection	+60 VDC
Digital Output	
Channels	6
Type	Isolated Open Collector
Sink/Source (NPN/PNP)	Sink
Load Voltage	+5 ~ +50 VDC
Load Current	500 mA/channel
Overvoltage Protection	+60 VDC
Overload Protection	1.3 A
Short-circuit Protection	Yes
Power on Value	Programmable
Safe Value	Programmable

1.4.16 U-7551M Specifications

Table 18 1-4-16 U-7551M Specifications

System Specifications

CPU Module	
CPU	32-bit CPU (400 MHz)
Watchdog Timer	Module, Communication(Programmable)
Isolation	
2-way Isolation	I/O: 2500 VDC
EMS Protection	
ESD (IEC 61000-4-2)	±4 kV Contact for each terminal ±8 kV Air for random point
EFT (IEC 61000-4-4)	±4 kV for Power Line
LED Indicators	
Status	Run, Ethernet, I/O
Ethernet	
Ports	2 x RJ-45, 10/100 Base-TX, Switch Ports
PoE	Yes
LAN bypass	Yes
Security	ID, Password and IP Filter
Power	
Reverse Polarity Protection	Yes
Consumption	3.1 W
Powered from PoE	IEEE 802.3af, Class2
Powered from Terminal Block	+12 ~ +48 VDC
Mechanical	
Dimensions (mm)	97 x 120 x 47 (W x L x H)
Installation	DIN-Rail mounting
Environment	
Operating Temperature	-25 °C ~ +75 °C
Storage Temperature	-30 °C ~ +80 °C
Humidity	10 ~ 90% RH, Non-condensing

I/O Specifications

Digital Input/Counter	
Channels	16
Type	Wet Contact
Sink/Source (NPN/PNP)	Sink/Source
ON Voltage Level	+10 ~ +50 VDC
OFF Voltage Level	+4 VDC (max.)
Max. Counts	4,294,967,295 (32-bit)
Frequency	100 Hz
Min. Pulse Width	5 ms
Input Impedance	10 kΩ
Overvoltage Protection	+70 VDC

1.4.17 U-7552M Specifications

Table 19 1-4-17 U-7552M Specifications

System Specifications

CPU Module	
CPU	32-bit CPU (400 MHz)
Watchdog Timer	Module, Communication(Programmable)
Isolation	
2-way Isolation	I/O: 2500 VDC
EMS Protection	
ESD (IEC 61000-4-2)	±4 kV Contact for each terminal ±8 kV Air for random point
EFT (IEC 61000-4-4)	±2 kV for Power Line
Surge (IEC 61000-4-5)	±2 kV for Power Line
LED Indicators	
Status	Run, Ethernet, I/O
Ethernet	
Ports	2 x RJ-45, 10/100 Base-TX, Swtich Ports
PoE	Yes
LAN bypass	Yes
Security	ID, Password and IP Filter
Power	
Reverse Polarity Protection	Yes
Consumption	3.5 W
Powered from PoE	IEEE 802.3af, Class2
Powered from Terminal Block	+12 ~ +48 VDC
Mechanical	
Dimensions (mm)	97 x 120 x 47 (W x L x H)
Installation	DIN-Rail mounting
Environment	
Operating Temperature	-25 °C ~ +75 °C
Storage Temperature	-30 °C ~ +80 °C
Humidity	10 ~ 90% RH, Non-condensing

I/O Specifications

Digital Input/Counter	
Channels	8
Type	Wet Contact
Sink/Source (NPN/PNP)	Sink/Source
ON Voltage Level	+10 ~ +50 VDC
OFF Voltage Level	+4 VDC (max.)
Max. Counts	4,294,967,295 (32-bit)
Frequency	100 Hz
Min. Pulse Width	5 ms
Input Impedance	10 kΩ
Overvoltage Protection	+70 VDC
Digital Output	
Channels	8
Type	Isolated Open Collector
Sink/Source (NPN/PNP)	Source
Load Voltage	+10 ~ +40 VDC
Load Current	650 mA/channel at 25°C
Overvoltage Protection	+47 VDC
Short-circuit Protection	Yes
Power on Value	Programmable
Safe Value	Programmable

1.4.18 U-7553M Specifications

Table 20 1-4-18 U-7553M Specifications

System Specifications

CPU Module	
CPU	32-bit CPU (400 MHz)
Watchdog Timer	Module, Communication(Programmable)
Isolation	
2-way Isolation	I/O: 2500 VDC
EMS Protection	
ESD (IEC 61000-4-2)	±4 kV Contact for each terminal ±8 kV Air for random point
EFT (IEC 61000-4-4)	±4 kV for Power Line
LED Indicators	
Status	Run, Ethernet, I/O
Ethernet	
Ports	2 x RJ-45, 10/100 Base-TX, Switch Ports
PoE	Yes
LAN bypass	Yes
Security	ID, Password and IP Filter
Power	
Reverse Polarity Protection	Yes
Consumption	4.1 W
Powered from PoE	IEEE 802.3af, Class2
Powered from Terminal Block	+12 ~ +48 VDC
Mechanical	
Dimensions (mm)	97 x 120 x 47 (W x L x H)
Installation	DIN-Rail mounting
Environment	
Operating Temperature	-25 °C ~ +75 °C
Storage Temperature	-30 °C ~ +80 °C
Humidity	10 ~ 90% RH, Non-condensing

I/O Specifications

Digital Input/Counter	
Channels	16
Type	Dry Contact
Sink/Source (NPN/PNP)	Source
ON Voltage Level	Close to GND
OFF Voltage Level	Open
Max. Counts	4,294,967,295 (32-bit)
Frequency	100 Hz
Min. Pulse Width	5 ms
Effective Distance	500m (max.)

1.4.19 U-7555M Specifications

Table 21 1-4-19 U-7555M Specifications

System Specifications

CPU Module	
CPU	32-bit CPU (400 MHz)
Watchdog Timer	Module, Communication (Programmable)
Isolation	
2-way Isolation	I/O: 2500 VDC
EMS Protection	
EFT (IEC 61000-4-4)	±2 kV for Power Line
ESD (IEC 61000-4-2)	±4 kV Contact for each terminal ±8 kV Air for random point
Surge (IEC 61000-4-5)	±2 kV for Power Line
LED Indicators	
Status	Run, Ethernet, I/O
Ethernet	
Ports	2 x RJ-45, 10/100 Base-TX, Switch Ports
PoE	Yes
LAN bypass	Yes
Security	ID, Password and IP Filter
Power	
Reverse Polarity Protection	Yes
Consumption	4.0 W
Powered from PoE	IEEE 802.3af, Class2
Powered from Terminal Block	+12 ~ +48 VDC
Mechanical	
Dimensions (mm)	97 x 120 x 47 (W x L x H)
Installation	DIN-Rail mounting
Environment	
Operating Temperature	-25 °C ~ +75 °C
Storage Temperature	-30 °C ~ +80 °C
Humidity	10 ~ 90% RH, Non-condensing

I/O Specifications

Digital Input/Counter	
Channels	8
Type	Dry Contact Wet Contact
Sink/Source (NPN/PNP)	Dry: Source Wet: Sink/Source
On Voltage Level	Dry: Close to GND Wet: +10 ~ +50 VDC
OFF Voltage Level	Dry: Open Wet: +4 VDC (max.)
Max. Counts	4,294,967,295 (32-bit)
Frequency	100 Hz
Min. Pulse Width	5 ms
Effective Distance	500m (max.)
Input Impedance	10 kΩ
Overvoltage Protection	+70 VDC
Digital Output	
Channels	8
Type	Isolated Open Collector
Sink/Source (NPN/PNP)	Source
Load Voltage	+10 ~ +40 VDC
Load Current	650 mA/Channel at 25°C
Overvoltage Protection	+47 VDC
Short-circuit Protection	Yes
Power on Value	Programmable
Safe Value	Programmable

1.4.20 U-7558M Specifications

Table 22 1-4-20 U-7558M Specifications

System Specifications

CPU Module	
CPU	32-bit CPU (400 MHz)
Watchdog Timer	Module, Communication(Programmable)
Isolation	
2-way Isolation	I/O: 2500 VDC
EMS Protection	
ESD (IEC 61000-4-2)	±4 kV Contact for each terminal ±8 kV Air for random point
EFT (IEC 61000-4-4)	±4 kV for Power Line
LED Indicators	
Status	Run, Ethernet, I/O
Ethernet	
Ports	2 x RJ-45, 10/100 Base-TX, Swtich Ports
PoE	Yes
LAN bypass	Yes
Security	ID, Password and IP Filter
Power	
Reverse Polarity Protection	Yes
Consumption	2.7 W
Powered from PoE	IEEE 802.3af, Class2
Powered from Terminal Block	+12 ~ +48 VDC
Mechanical	
Dimensions (mm)	97 x 120 x 47 (W x L x H)
Installation	DIN-Rail mounting
Environment	
Operating Temperature	-25 °C ~ +75 °C
Storage Temperature	-30 °C ~ +80 °C
Humidity	10 ~ 90% RH, Non-condensing

I/O Specifications

Digital Input/Counter	
Channels	8
Type	Wet Contact
Sink/Source (NPN/PNP)	Sink/Source
ON Voltage Level	80 ~ 250 VAC ±90 ~ ±250 VDC
OFF Voltage Level	30 VAC (max.) ±30 VDC (max.)
Max. Counts	4,294,967,295 (32-bit)
Frequency	100 Hz
Min. Pulse Width	5 ms
Input Impedance	150 kΩ
Overvoltage Protection	300 VAC

1.4.21 U-7559M Specifications

Table 23 1-4-21 U-7559M Specifications

System Specifications

CPU Module	
CPU	32-bit CPU (400 MHz)
Watchdog Timer	Module, Communication(Programmable)
Isolation	
2-way Isolation	I/O: 2500 VDC
EMS Protection	
ESD (IEC 61000-4-2)	±4 kV Contact for each terminal ±8 kV Air for random point
EFT (IEC 61000-4-4)	±4 kV for Power Line
LED Indicators	
Status	Run, Ethernet, I/O
Ethernet	
Ports	2 x RJ-45, 10/100 Base-TX, Swtich Ports
PoE	Yes
LAN bypass	Yes
Security	ID, Password and IP Filter
Power	
Reverse Polarity Protection	Yes
Consumption	2.7 W
Powered from PoE	IEEE 802.3af, Class2
Powered from Terminal Block	+12 ~ +48 VDC
Mechanical	
Dimensions (mm)	97 x 120 x 47 (W x L x H)
Installation	DIN-Rail mounting
Environment	
Operating Temperature	-25 °C ~ +75 °C
Storage Temperature	-30 °C ~ +80 °C
Humidity	10 ~ 90% RH, Non-condensing

I/O Specifications

Digital Input/Counter	
Channels	8
Type	Wet Contact
Sink/Source (NPN/PNP)	Sink/Source
ON Voltage Level	10 ~ 80 VAC ±15 ~ ±80 VDC
OFF Voltage Level	3 VAC (max.) ±3 VDC (max.)
Max. Counts	4,294,967,295 (32-bit)
Frequency	100 Hz
Min. Pulse Width	5 ms
Input Impedance	30 kΩ
Overvoltage Protection	120 VAC

1.4.22 U-7560M Specifications

Table 24 1-4-22 U-7560M Specifications

System Specifications

CPU Module	
CPU	32-bit CPU (400 MHz)
Watchdog Timer	Module, Communication (Programmable)
Isolation	
2-way Isolation	I/O: 3000 VDC
EMS Protection	
EFT (IEC 61000-4-4)	±4 kV for Power Line
ESD (IEC 61000-4-2)	±4 kV Contact for each terminal ±8 kV Air for random point
Surge (IEC 61000-4-5)	±2 kV for Power Line
LED Indicators	
Status	Run, Ethernet, I/O
Ethernet	
Ports	2 x RJ-45, 10/100 Base-TX, Swtich Ports
PoE	Yes
LAN bypass	Yes
Security	ID, Password and IP Filter
Power	
Reverse Polarity Protection	Yes
Consumption	3.8 W
Powered from PoE	IEEE 802.3af, Class2
Powered from Terminal Block	+12 ~ +48 VDC
Mechanical	
Dimensions (mm)	97 x 120 x 47 (W x L x H)
Installation	DIN-Rail mounting
Environment	
Operating Temperature	-25 °C ~ +75 °C
Storage Temperature	-30 °C ~ +80 °C
Humidity	10 ~ 90% RH, non-condensing

I/O Specifications

Digital Input/Counter	
Channels	6
Type	Wet Contact
Sink/Source (NPN/PNP)	Sink/Source
ON Voltage Level	+10 ~ +50 VDC
OFF Voltage Level	+4 VDC (max.)
Max. Counts	4,294,967,295 (32-bit)
Frequency	100 Hz
Min. Pulse Width	5 ms
Input Impedance	10 kΩ
Overvoltage Protection	+70 VDC

Relay Output	
Channels	6
Type	Power Relay, Form A (SPST N.O.)
Contact Rating	5 A @ 250 VAC/24 VDC (Resistive Load)
Operate Time	10 ms (max.)
Release Time	5 ms (max.)
Electrical Endurance	10 ⁵ ops.
Mechanical Endurance	2 × 10 ⁷ ops.
Power on Value	Programmable
Safe Value	Programmable

1.4.23 U-7561M Specifications

Table 25 1-4-23 U-7561M Specifications

System Specifications

CPU Module	
CPU	32-bit CPU (400 MHz)
Watchdog Timer	Module, Communication(Programmable)
Isolation	
2-way Isolation	I/O: 3000 VDC
EMS Protection	
ESD (IEC 61000-4-2)	±4 kV Contact for each terminal ±8 kV Air for random point
EFT (IEC 61000-4-4)	±4 kV for Power Line
Surge (IEC 61000-4-5)	±2 kV for Power Line
LED Indicators	
Status	Run, Ethernet, I/O
Ethernet	
Ports	2 x RJ-45, 10/100 Base-TX, Switch Ports
PoE	Yes
LAN bypass	Yes
Security	ID, Password and IP Filter
Power	
Reverse Polarity Protection	Yes
Consumption	4.6 W
Powered from PoE	IEEE 802.3af, Class2
Powered from Terminal Block	+12 ~ +48 VDC
Mechanical	
Dimensions (mm)	97 x 120 x 47 (W x L x H)
Installation	DIN-Rail mounting
Environment	
Operating Temperature	-25 °C ~ +75 °C
Storage Temperature	-30 °C ~ +80 °C
Humidity	10 ~ 90% RH, Non-condensing

I/O Specifications

Relay Output	
Channels	11
Type	Power Relay, Form A (SPST N.O.)
Contact Rating	5 A @ 250 VAC/24 VDC (Resistive Load)
Operate Time	10 ms (max.)
Release Time	5 ms (max.)
Electrical Endurance	10 ⁵ ops.
Mechanical Endurance	2 × 10 ⁷ ops.
Power on Value	Programmable
Safe Value	Programmable

1.4.24 U-7567M Specifications

Table 26 1-4-24 U-7567M Specifications

System Specifications

CPU Module	
CPU	32-bit CPU (400 MHz)
Watchdog Timer	Module, Communication(Programmable)
Isolation	
2-way Isolation	I/O: 3000 VDC
EMS Protection	
ESD (IEC 61000-4-2)	±4 kV Contact for each terminal ±8 kV Air for random point
EFT (IEC 61000-4-4)	±4 kV for Power Line
Surge (IEC 61000-4-5)	±2 kV for Power Line
LED Indicators	
Status	Run, Ethernet, I/O
Ethernet	
Ports	2 x RJ-45, 10/100 Base-TX, Swtich Ports
PoE	Yes
LAN bypass	Yes
Security	ID, Password and IP Filter
Power	
Reverse Polarity Protection	Yes
Consumption	4.1 W
Powered from PoE	IEEE 802.3af, Class2
Powered from Terminal Block	+12 ~ +48 VDC
Mechanical	
Dimensions (mm)	97 x 120 x 47 (W x L x H)
Installation	DIN-Rail mounting
Environment	
Operating Temperature	-25 °C ~ +75 °C
Storage Temperature	-30 °C ~ +80 °C
Humidity	10 ~ 90% RH, Non-condensing

I/O Specifications

Relay Output	
Channels	8
Type	Power Relay, Form A (SPST N.O.)
Contact Rating	5 A @ 250 VAC/24 VDC (Resistive Load)
Operate Time	10 ms (max.)
Release Time	5 ms (max.)
Electrical Endurance	10 ⁵ ops.
Mechanical Endurance	2 × 10 ⁷ ops.
Power on Value	Programmable
Safe Value	Programmable

1.5 Wire Connections / Pin Assignments

1.5.1 U-7502M Wire Connections / Pin Assignments/Jumper Pic

Wire Connections

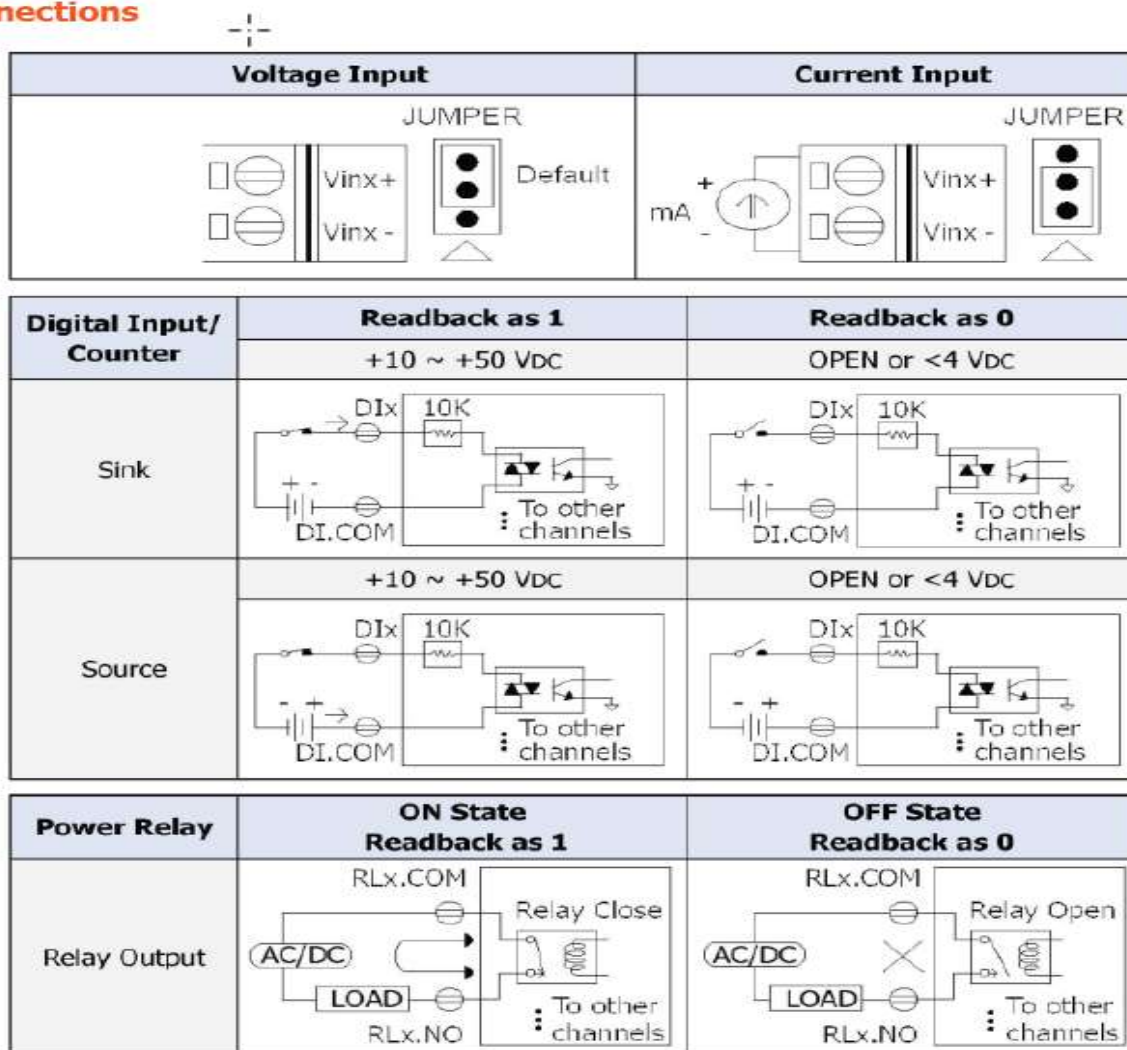

Pin Assignments

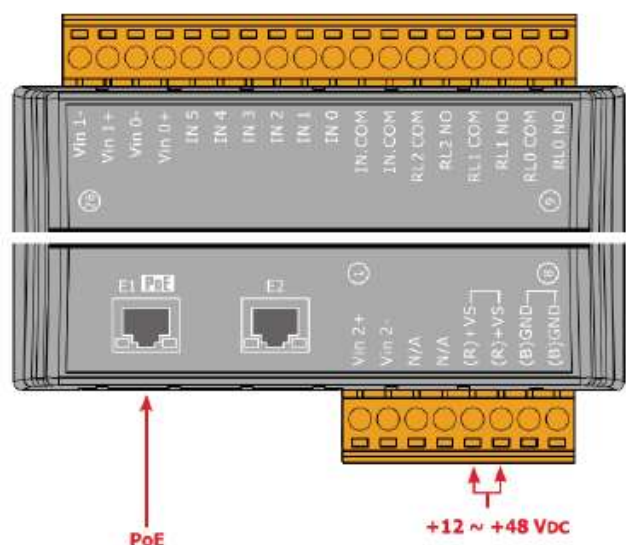

Jumper Location

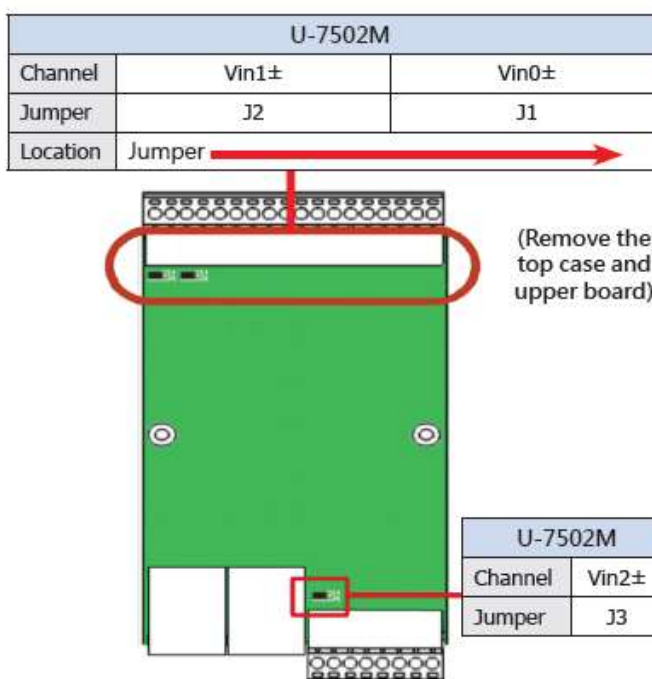
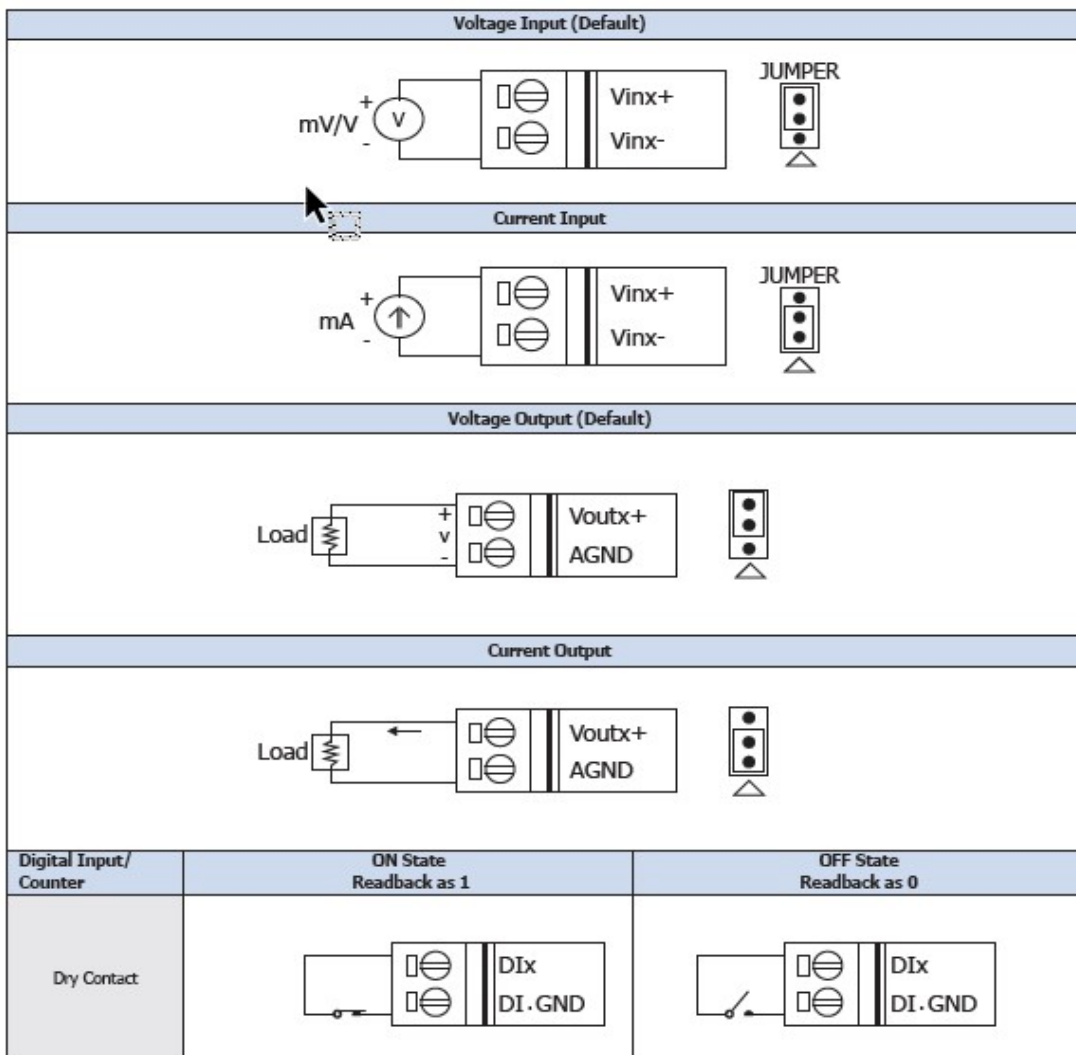

Figure 3 1-5-1 U-7502M Wire Connections / Pin Assignments/Jumper Pic

1.5.2 U-7504M Wire Connections / Pin Assignments/Jumper Pic

Wire Connections



Pin Assignments

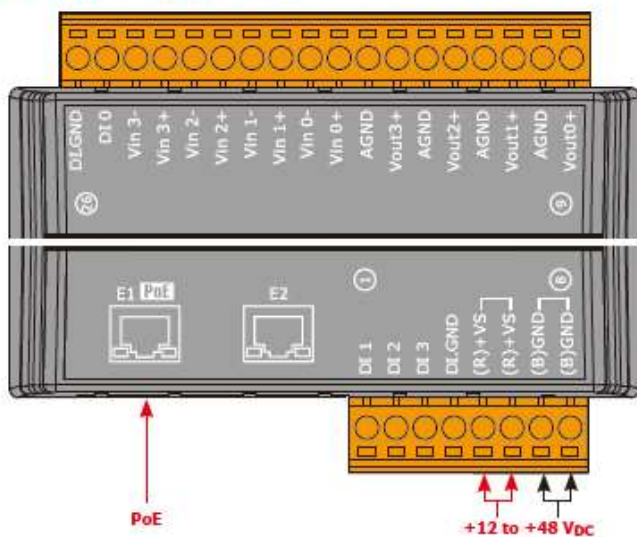

Jumper Location

U-7504M									
Channel	Vin3	Vin2	Vin1	Vin0	Vout3	Vout2	Vout1	Vout0	
Jumper	J4	J3	J2	J1	J8	J7	J6	J5	
Location	Jumper →								

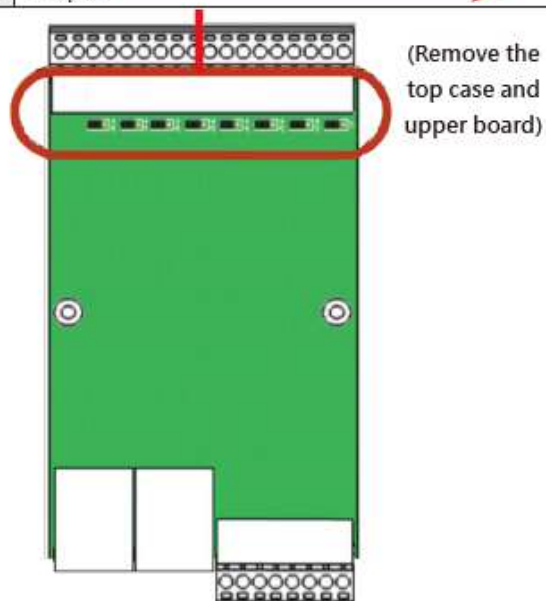

Figure 4 1-5-2 U-7504M Wire Connections / Pin Assignments/Jumper Pic

1.5.3 U-7515M Wire Connections / Pin Assignments

Wire Connections

Open Collector (Sink)	CH0, 1, 2, 5 and 6	CH3 and CH4
2-wire of RTD		
3-wire of RTD		

Pin Assignments

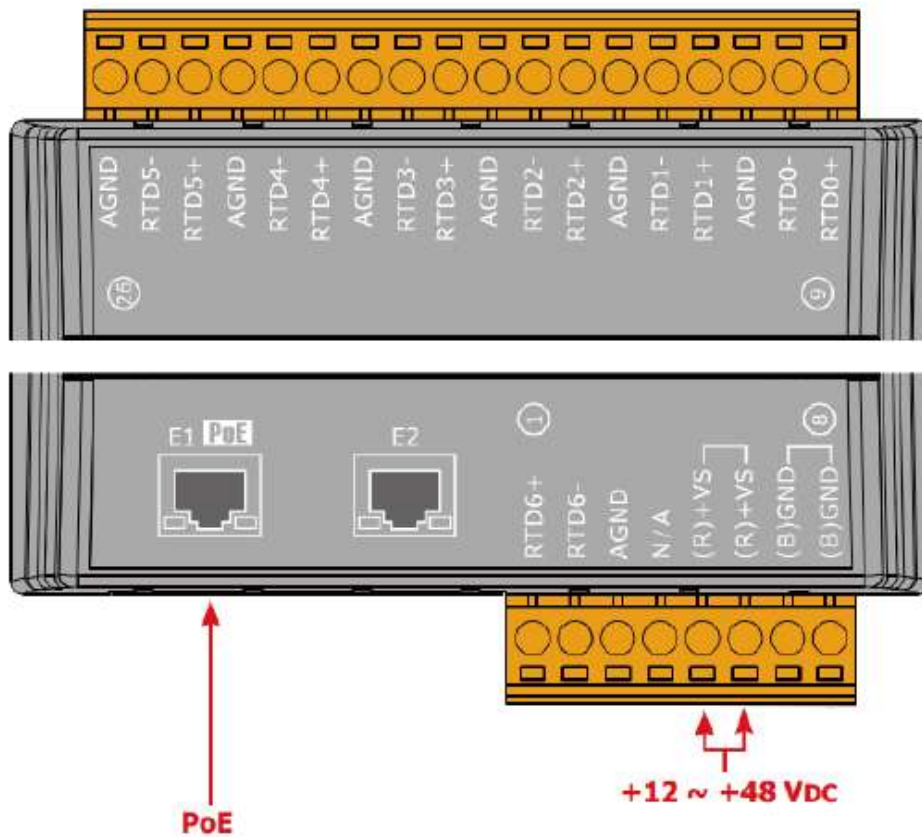
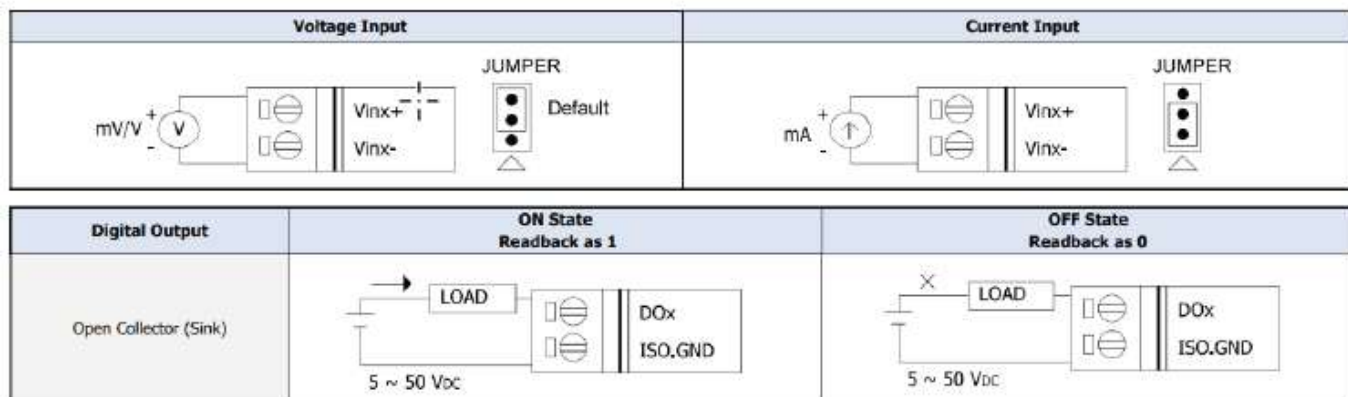

Figure 5 1-5-3 U-7515M Wire Connections / Pin Assignments

1.5.4 U-7517M Wire Connections/Pin Assignments/Jumper Pic

Wire Connections



Pin Assignments

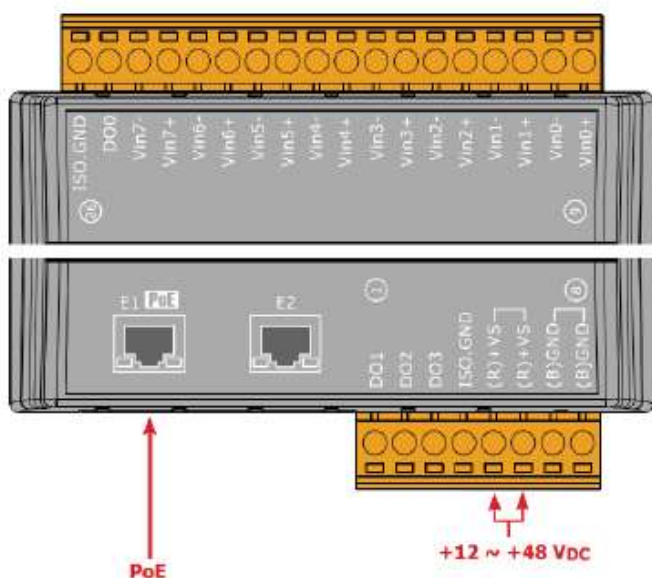

Jumper Location

U-7517M								
Channel	Vin7±	Vin6±	Vin5±	Vin4±	Vin3±	Vin2±	Vin1±	Vin0±
Jumper	J8	J7	J6	J5	J4	J3	J2	J1
Location								

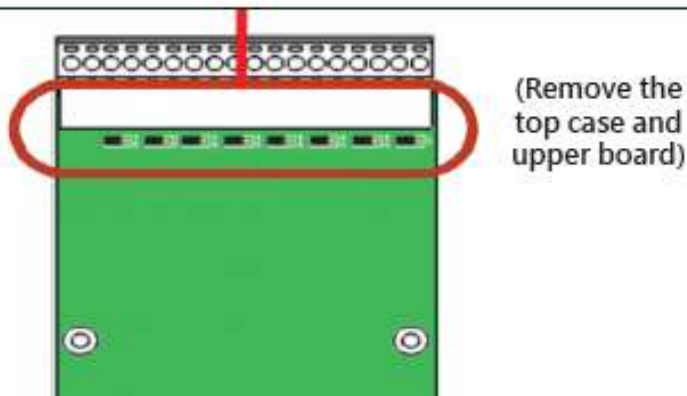
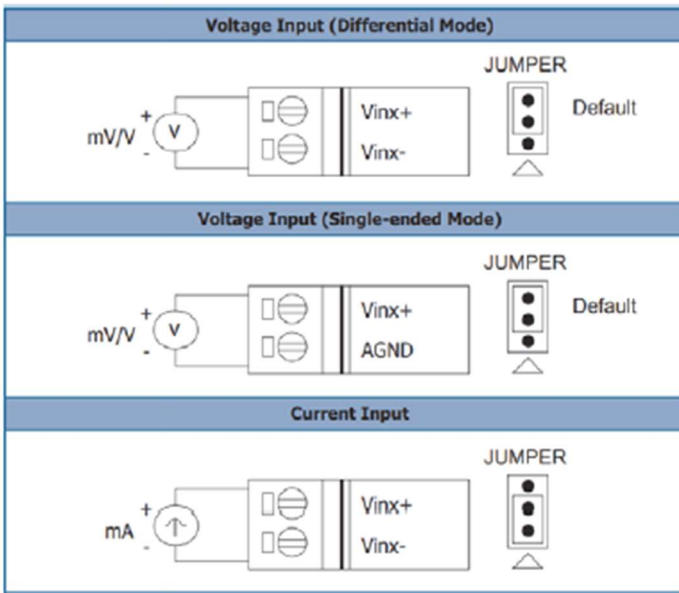

Figure 6 1-5-4 U-7517M Wire Connections/Pin Assignments/Jumper Pic

1.5.5 U-7517M-10 Wire Connections/Pin Assignments/Jumper Pic

Wire Connections



Pin Assignments

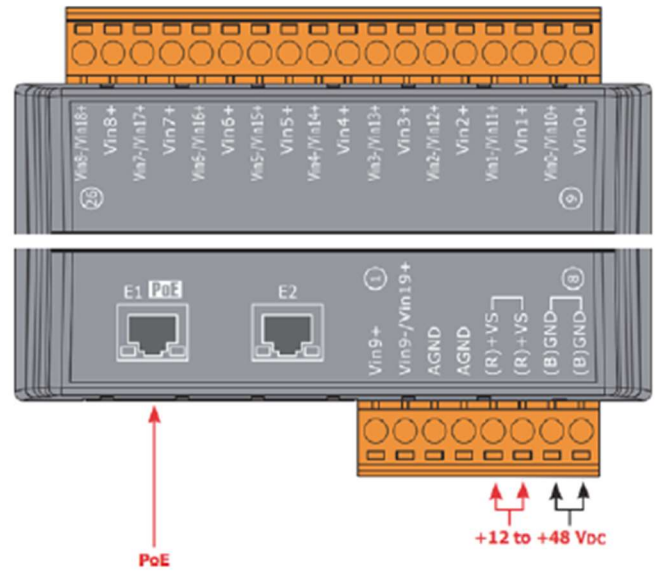

Jumper Location

U-7517M-10									
Channel	Vin8±	Vin7±	Vin6±	Vin5±	Vin4±	Vin3±	Vin2±	Vin1±	Vin0±
Jumper	J9	J8	J7	J6	J5	J4	J3	J2	J1
Location	Jumper →								

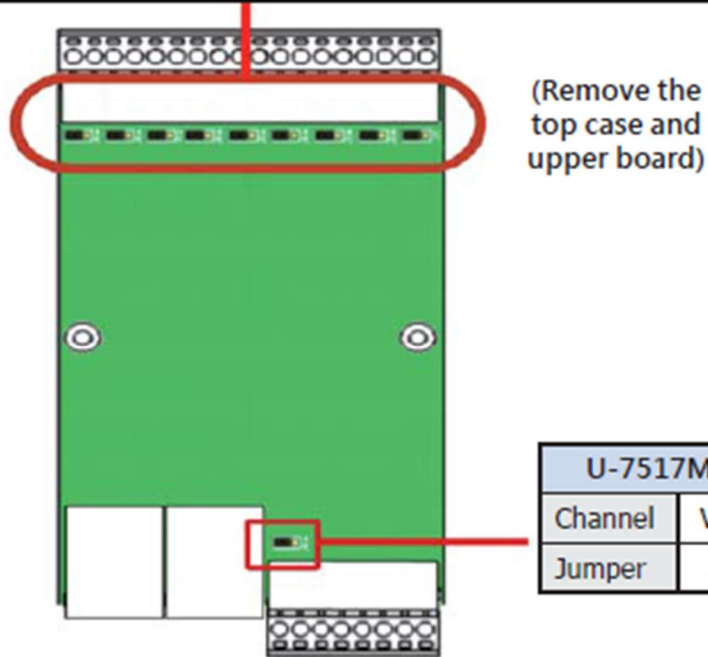
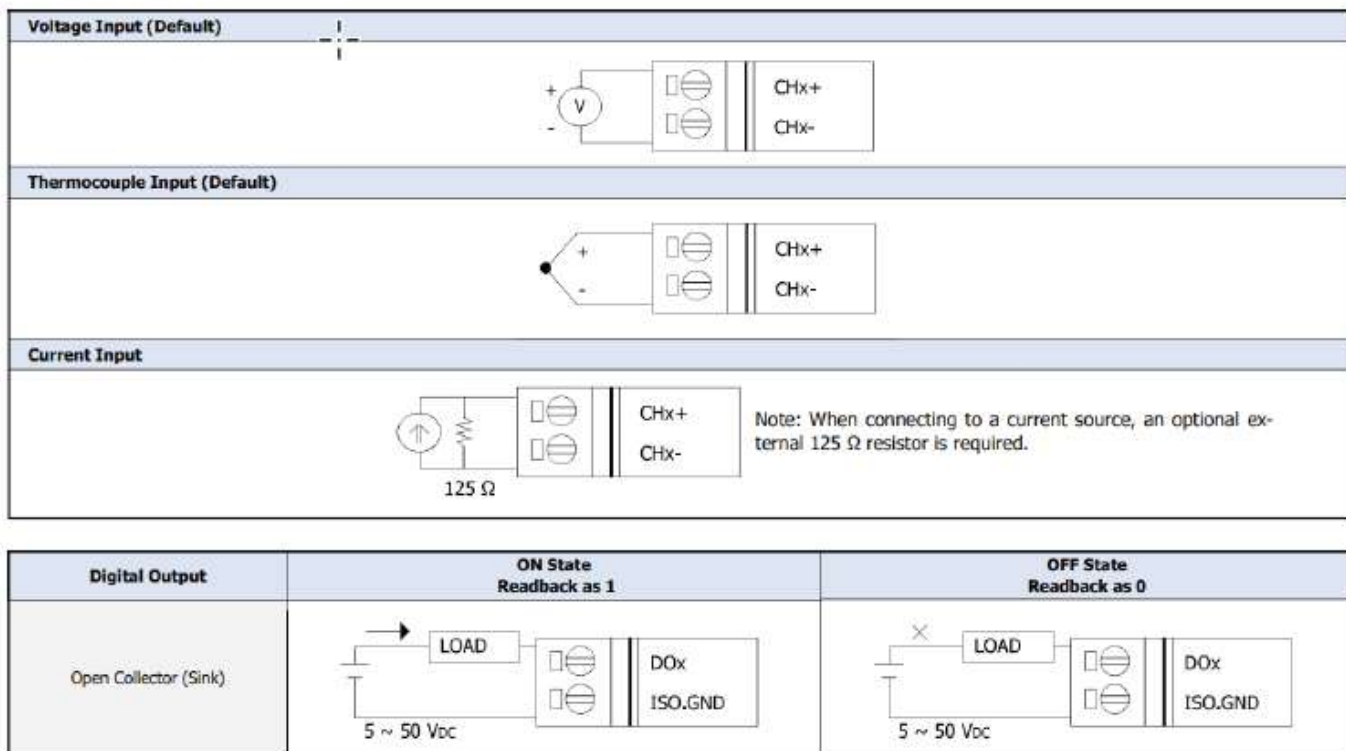

Figure 7 1-5-5 U-7517M-10 Wire Connections/Pin Assignments/Jumper Pic

1.5.6 U-7518ZM Wire Connections/Pin Assignments

Wire Connections



Pin Assignments

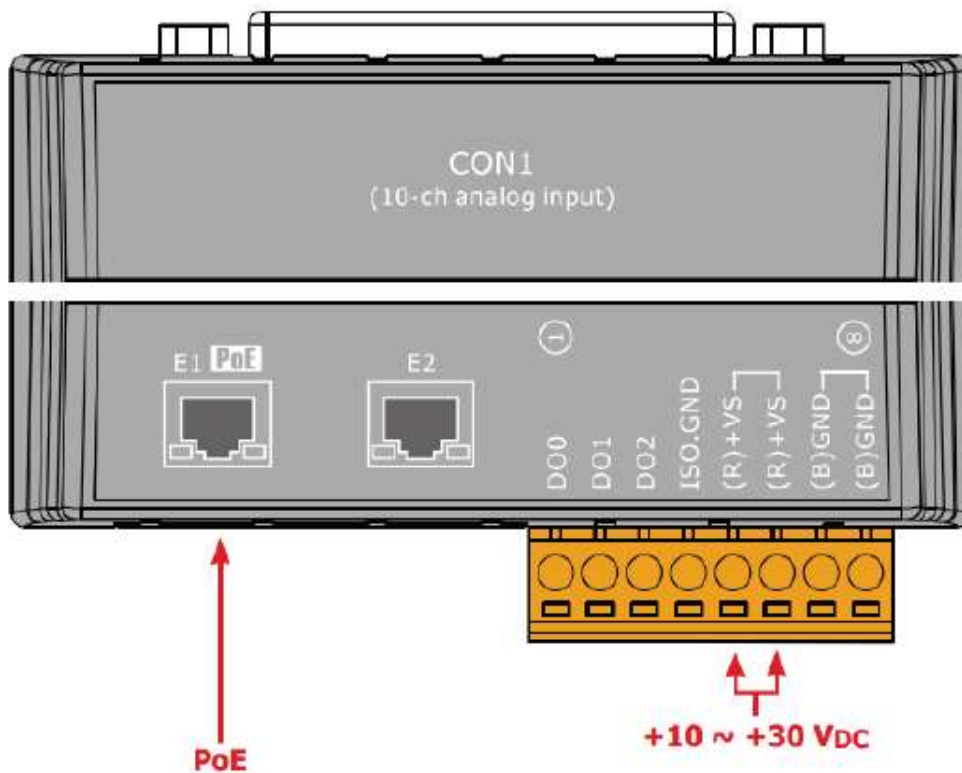
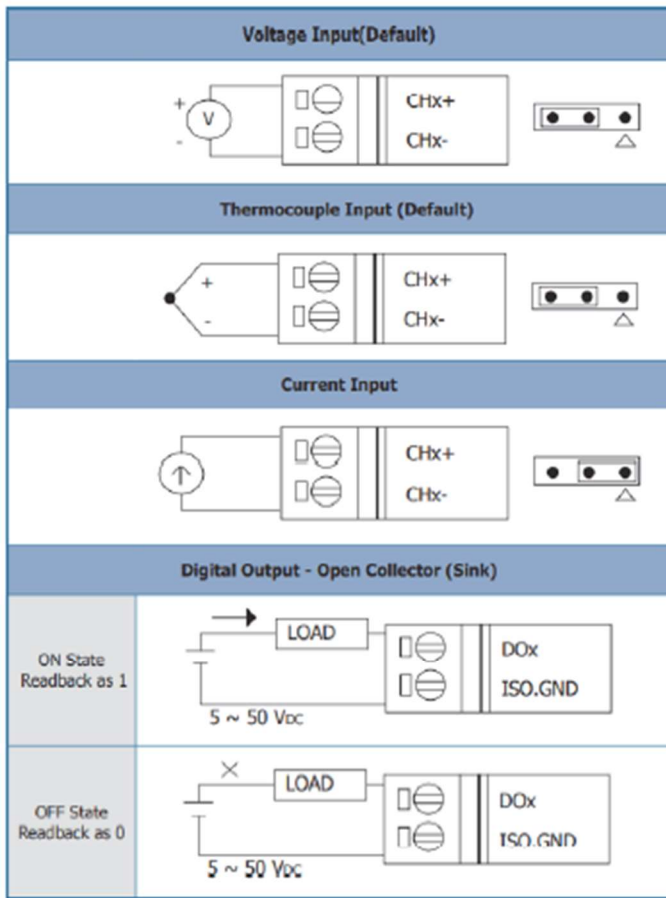

Figure 8 1-5-6 U-7518ZM Wire Connections/Pin Assignments

1.5.7 U-7519ZM Wire Connections/Pin Assignments/Jumper Pic

Wire Connections



Pin Assignments

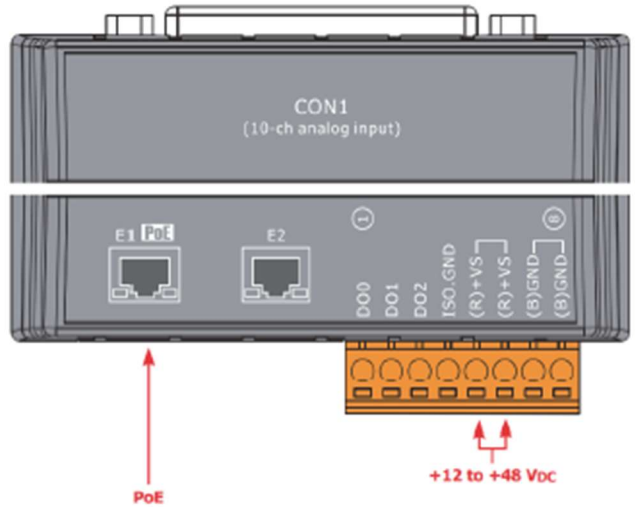

Jumper Location

U-7519ZM										
Channel	CH0±	CH1±	CH2±	CH3±	CH4±	CH5±	CH6±	CH7±	CH8±	CH9±
Jumper	J1	J2	J3	J4	J5	J6	J7	J8	J9	J10
Location	Jumper →									

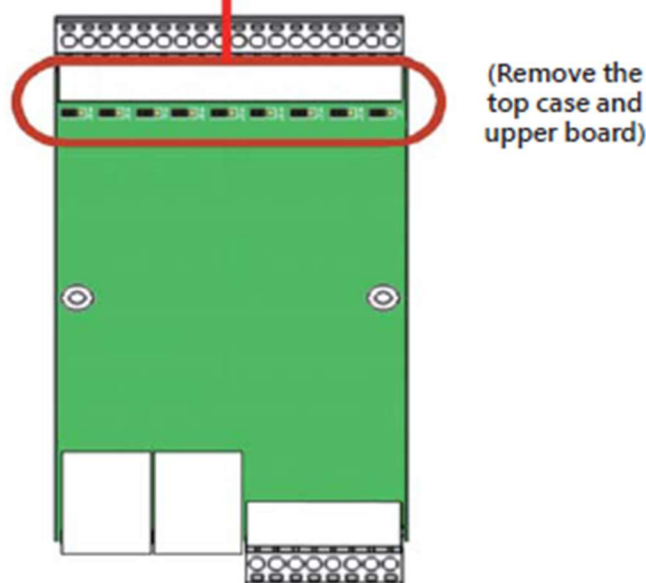
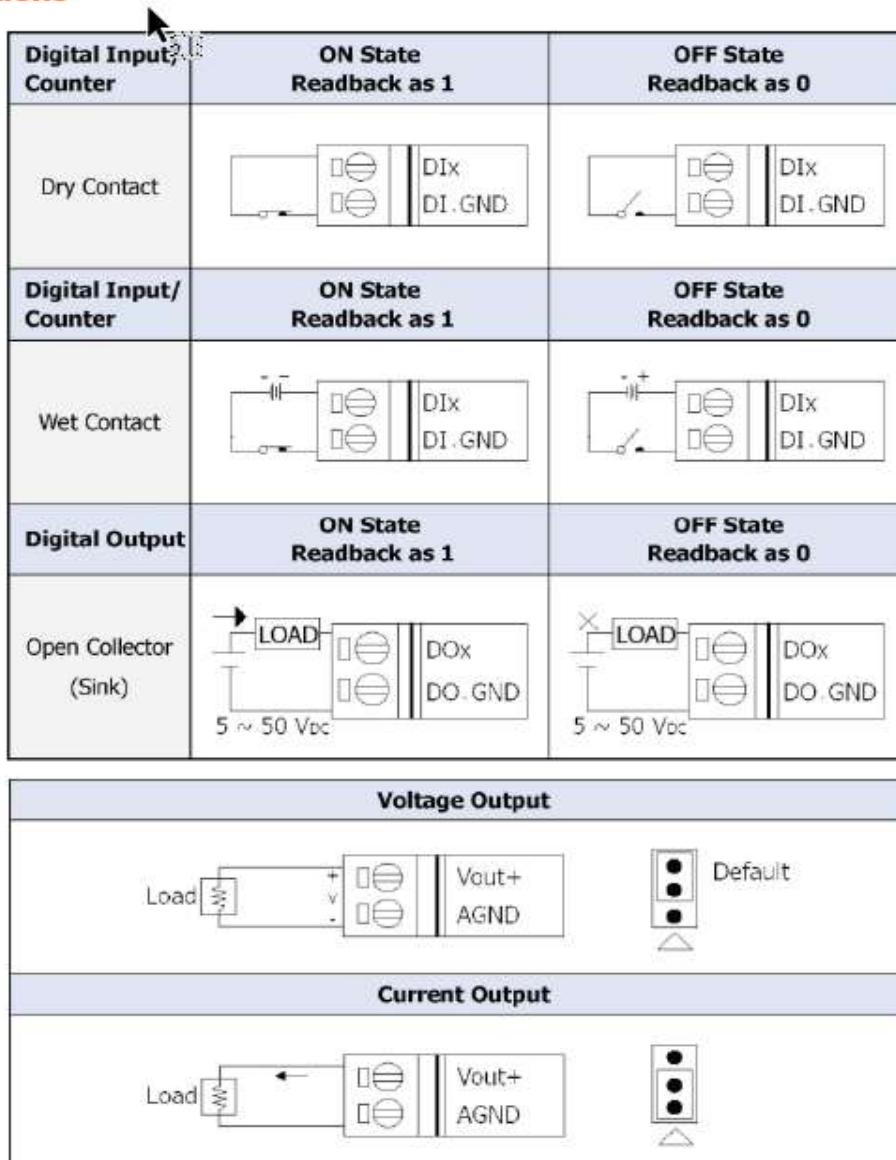

Figure 9 1-5-7 U-7519ZM Wire Connections/Pin Assignments/Jumper Pic

1.5.8 U-7524M Wire Connections/Pin Assignments/Jumper Pic

Wire Connections



Pin Assignments

Jumper Location

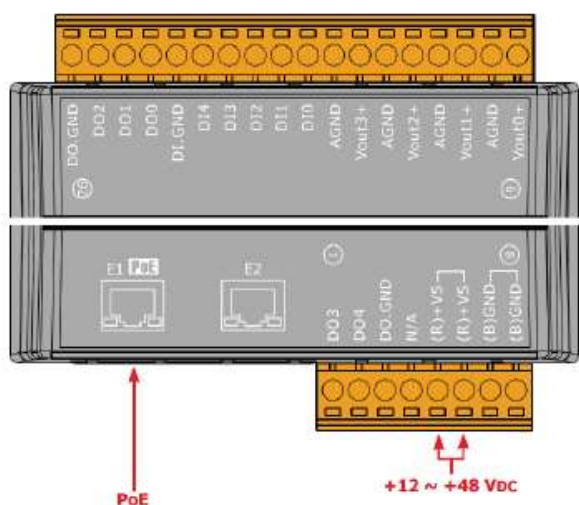

U-7524M				
Channel	Vout3+	Vout2+	Vout1+	Vout0+
Jumper	J4	J3	J2	J1
Location	Jumper →			

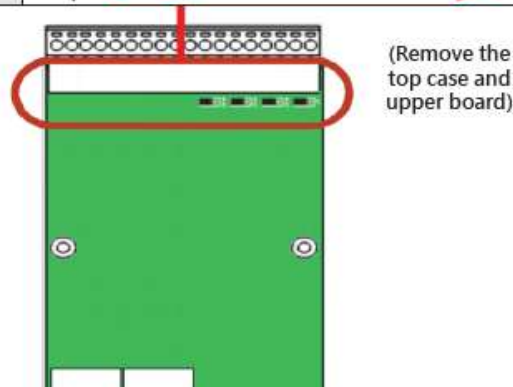
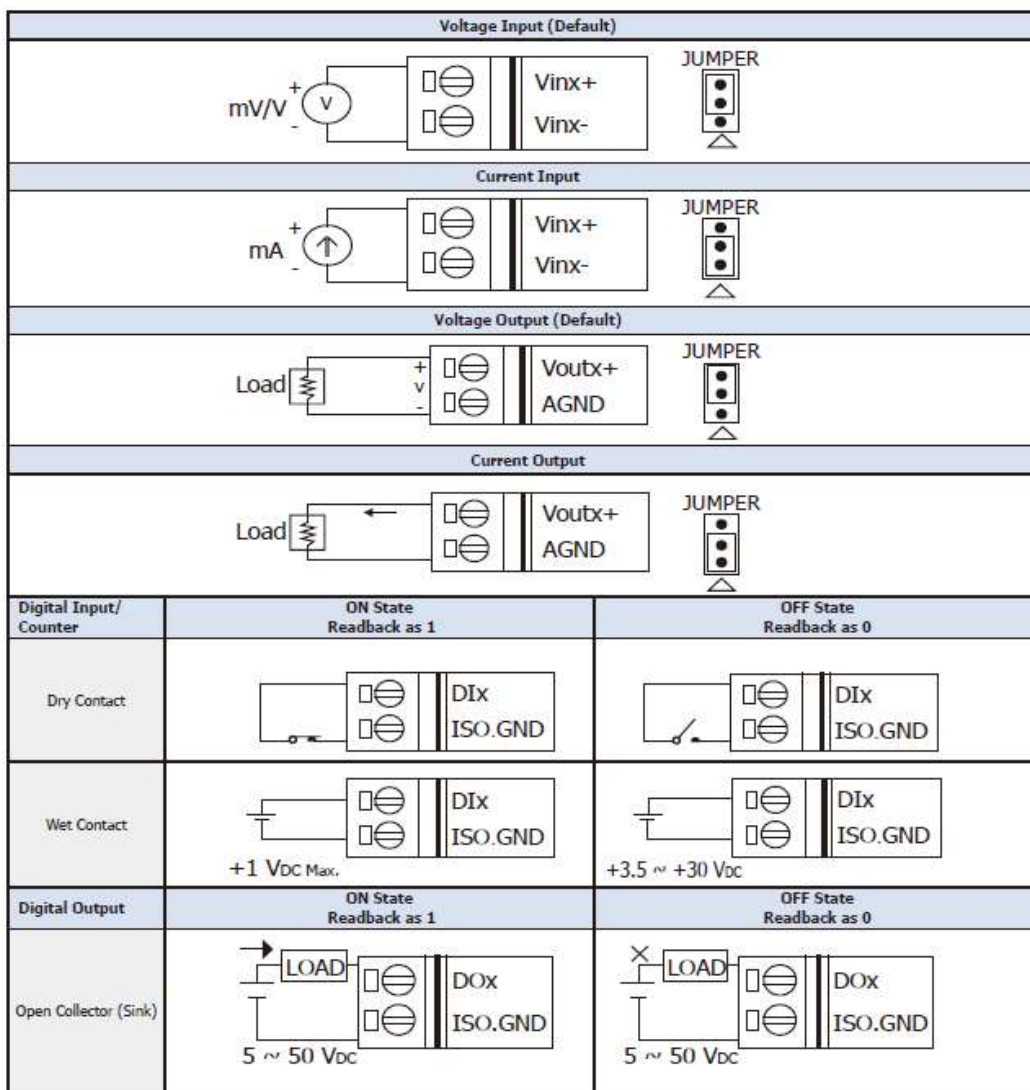

Figure 10 1-5-8 U-7524M Wire Connections/Pin Assignments/Jumper Pic

1.5.9 U-7526M Wire Connections/Pin Assignments/Jumper Pic

Wire Connections



Pin Assignments

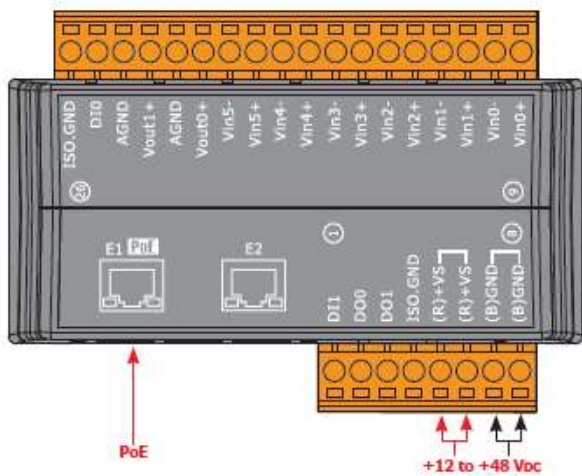

Jumper Location

U-7526M								
Channel	Vout1	Vout0	Vin5	Vin4	Vin3	Vin2	Vin1	Vin0
Jumper	J8	J7	J6	J5	J4	J3	J2	J1
Location	Jumper							

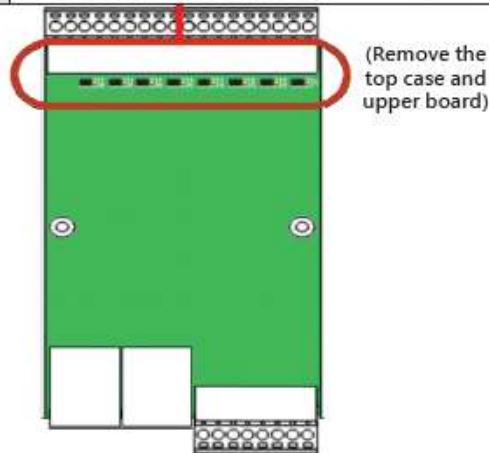
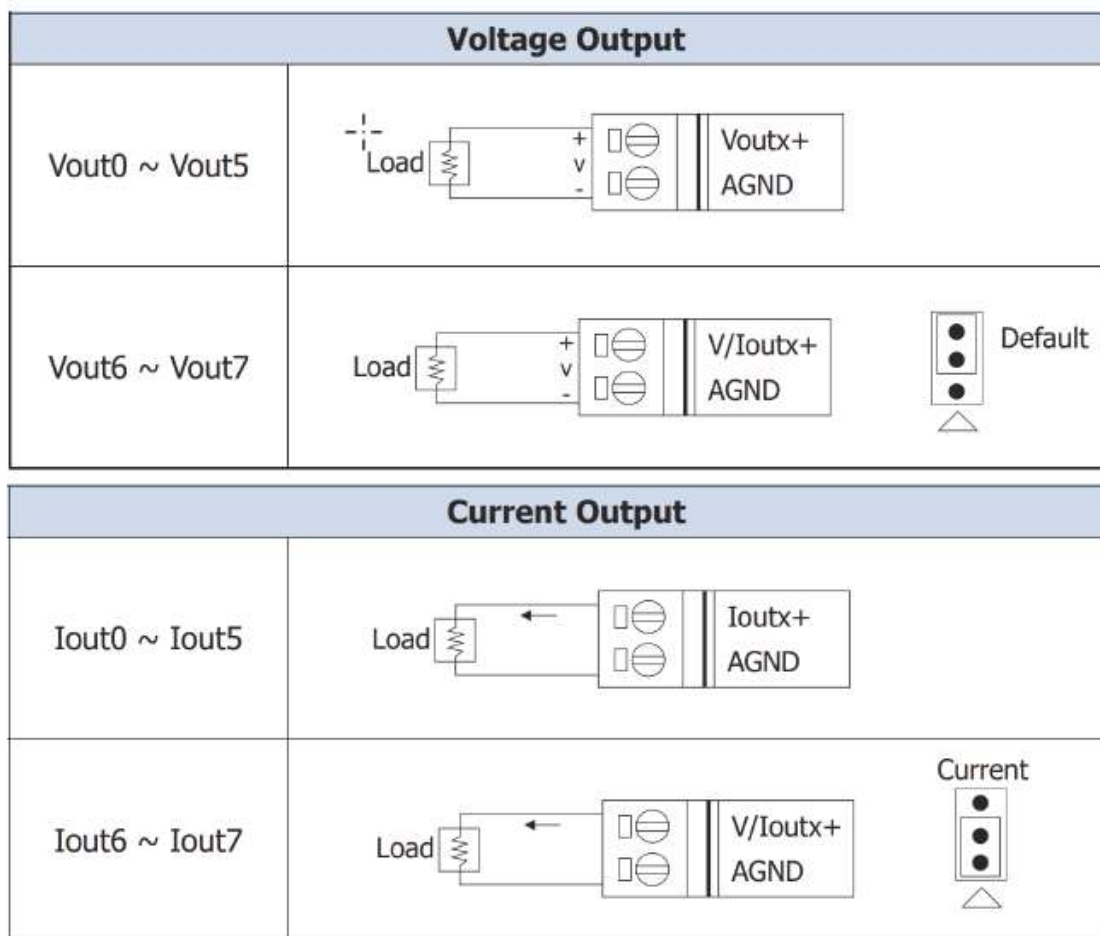

Figure 11 1-5-9 U-7526M Wire Connections/Pin Assignments/Jumper Pic

1.5.10 U-7528M Wire Connections/Pin Assignments/Jumper Pic

Wire Connections



Pin Assignments

Jumper Location

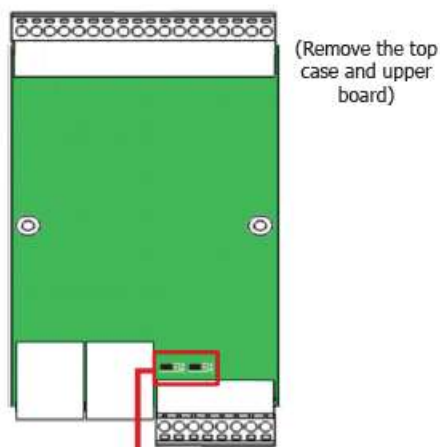
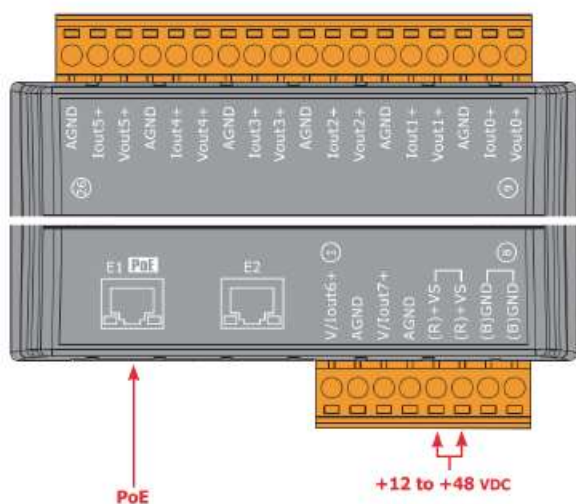

U-7528M		
Channel	V/Iout6+	V/Iout7+
Jumper	J1	J2
Location	Jumper	

Figure 12 1-5-10 U-7528M Wire Connections/Pin Assignments/Jumper Pic

1.5.11 U-7542M Wire Connections/Pin Assignments

Wire Connections

Output Type	ON State Readback as 1	
Drive Relay		DO.PWR DOx DO.GND
Resistance Load		DO.PWR DOx DO.GND
Output Type	OFF State Readback as 0	
Drive Relay		DO.PWR DOx DO.GND
Resistance Load		DO.PWR DOx DO.GND

Pin Assignments

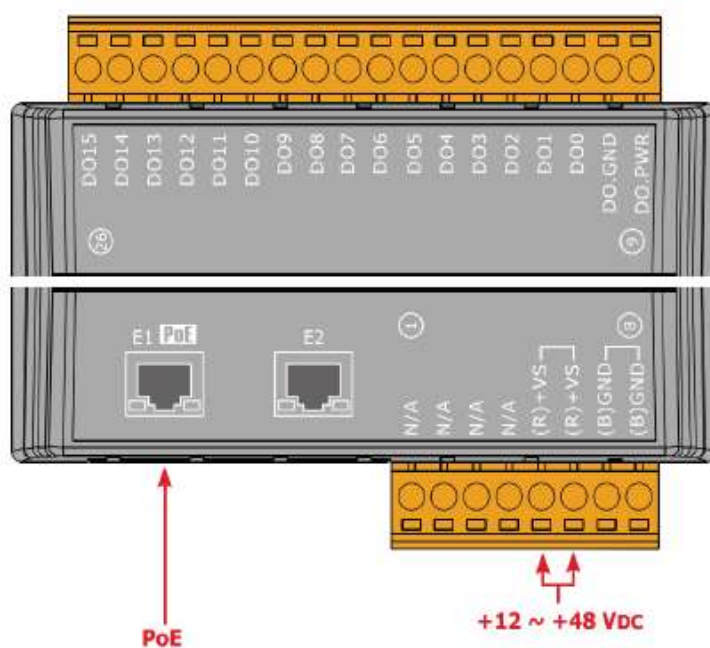

Figure 13 1-5-11 U-7542M Wire Connections/Pin Assignments

1.5.12 U-7544M Wire Connections/Pin Assignments

Wire Connections

Digital Input/Counter	Readback as 1	Readback as 0
Sink	+10 ~ +50 Vdc	OPEN or <4 Vdc
Source	+10 ~ +50 Vdc	OPEN or <4 Vdc

Output Type	ON State Readback as 1	OFF State Readback as 0
Drive Relay		
Resistance Load		

Pin Assignments

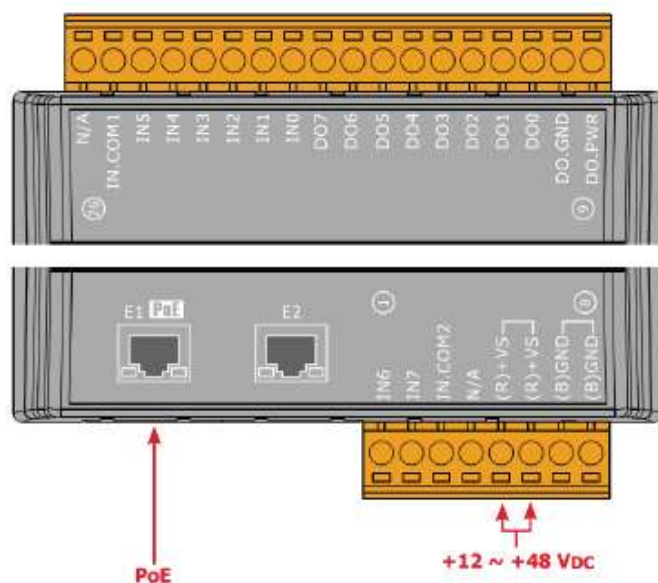
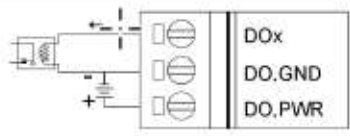
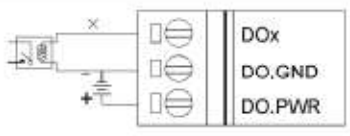
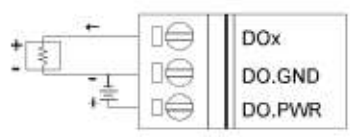
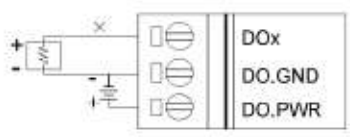

Figure 14 1-5-12 U-7544M Wire Connections/Pin Assignments

1.5.13 U-7545M Wire Connections/Pin Assignments

Wire Connections

Output Type	ON State Readback as 1	Output Type	OFF State Readback as 0
Drive Relay		Drive Relay	
Resistance Load		Resistance Load	

Pin Assignments

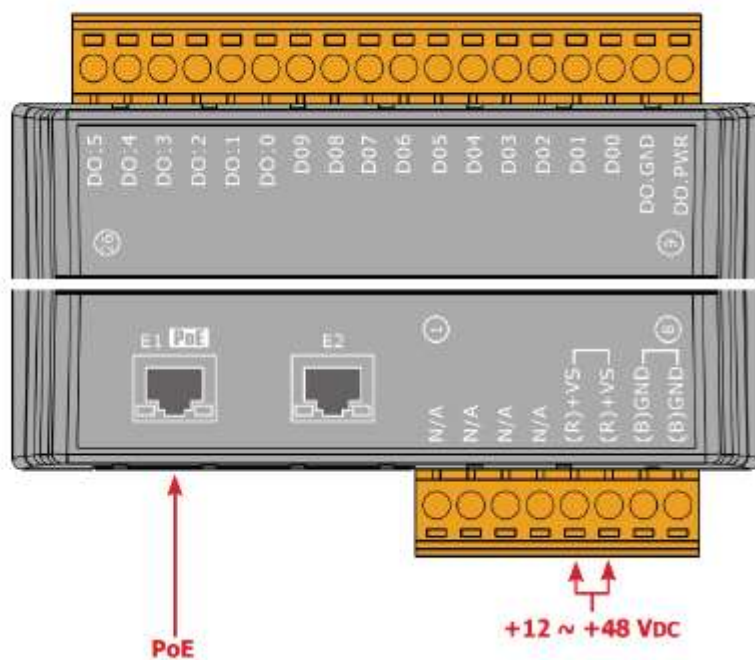

Figure 15 1-5-13 U-7545M Wire Connections/Pin Assignments

1.5.14 U-7550AM Wire Connections/Pin Assignments

Wire Connections

Digital Input/Counter	ON State Readback as 1	OFF State Readback as 0
Wet Contact (Sink)	<p>1 VDC Max.</p>	<p>+3.5 VDC ~ +50 VDC Max.</p>
	Close to GND	Open
Dry Contact (Source)		
	Digital Output	ON State Readback as 1
Open Collector (Sink)	<p>+5 ~ +50 VDC</p>	<p>+5 ~ +50 VDC</p>

Pin Assignments

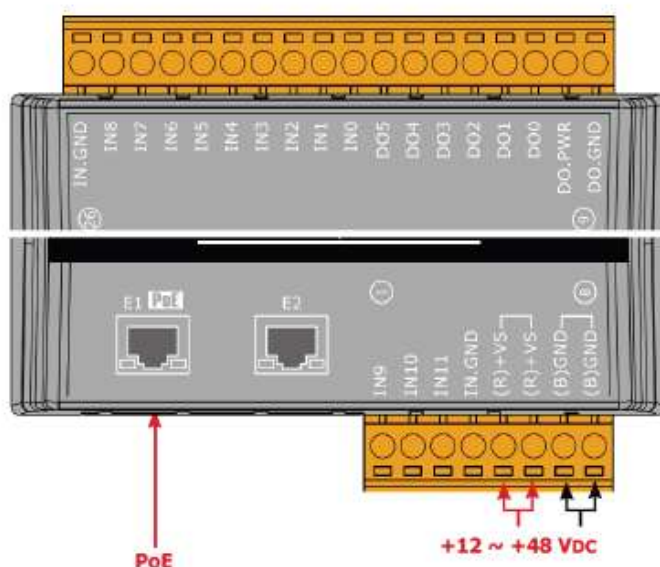

Figure 16 1-5-14 U-7550AM Wire Connections/Pin Assignments

1.5.15 U-7551M Wire Connections/Pin Assignments

Wire Connections

Digital Input/Counter	Readback as 1 +10 ~ +50 Vdc	Readback as 0 OPEN or <4 Vdc
Sink		
Source		

Pin Assignments

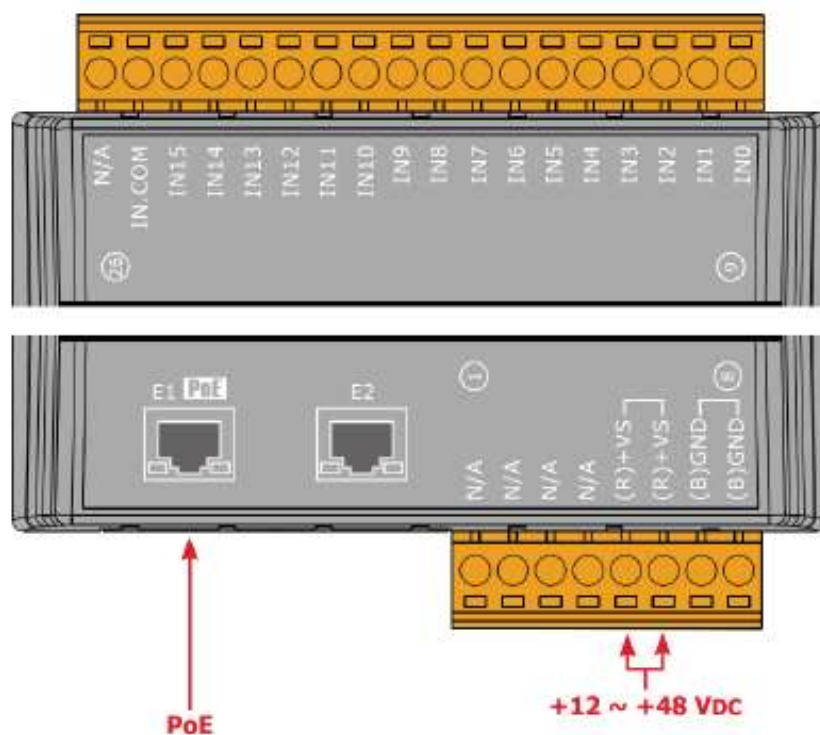

Figure 17 1-5-15 U-7551M Wire Connections/Pin Assignments

1.5.16 U-7552M Wire Connections/Pin Assignments

Wire Connections

Digital Input/Counter	Readback as 1 +10 ~ +50 Vdc	Readback as 0 OPEN or <4 Vdc
Sink		
Source		
Digital Output	ON State Readback as 1	OFF State Readback as 0
Source		

Pin Assignments

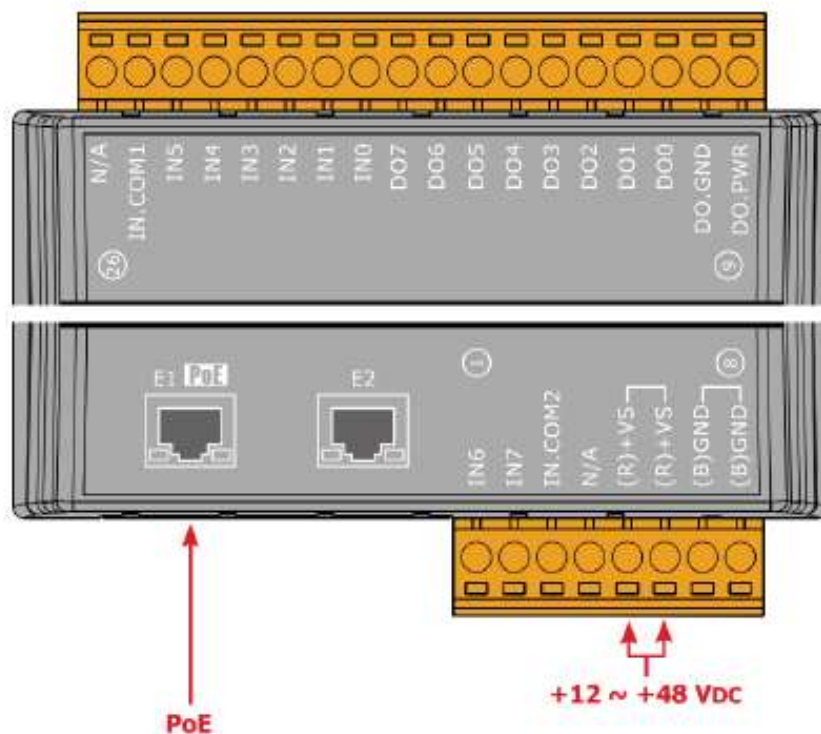

Figure 18 1-5-16 U-7552M Wire Connections/Pin Assignments

1.5.17 U-7553M Wire Connections/Pin Assignments

Wire Connections

Digital Input/Counter	ON State Readback as 1
Dry Contact	
	OFF State Readback as 0

Pin Assignments

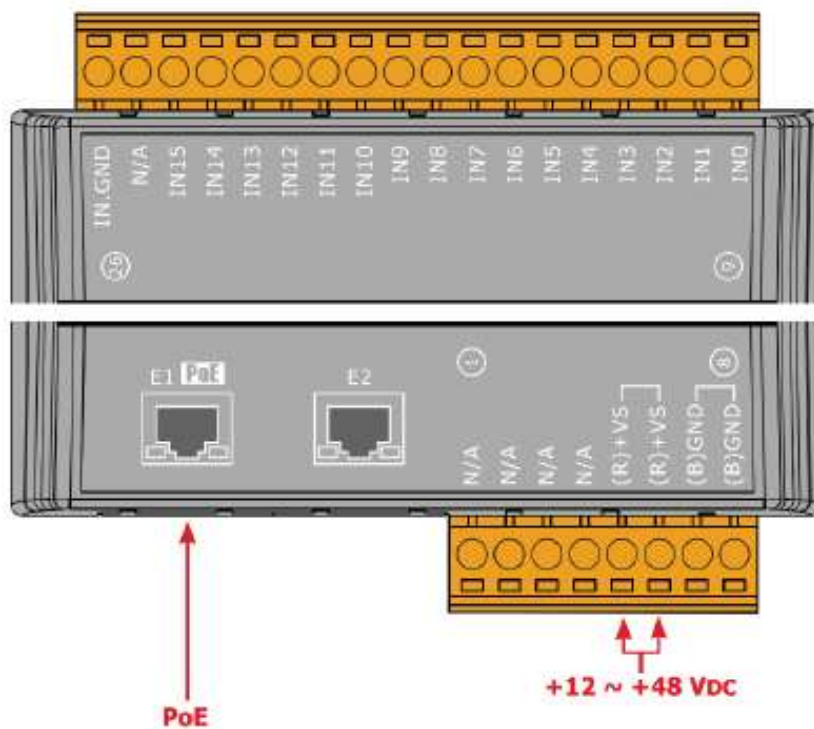

Figure 19 1-5-17 U-7553M Wire Connections/Pin Assignments

1.5.18 U-7555M Wire Connections / Pin Assignments

Wire Connections

Digital Input/Counter	Readback as 1 +10 ~ +50 Vdc	Readback as 0 OPEN or <4 Vdc
Wet Contact (Sink)		
Wet Contact (Source)		

Digital Input/Counter	ON State Readback as 1	OFF State Readback as 0
Dry Contact		

Digital Output	ON State Readback as 1	OFF State Readback as 0
Source		

Pin Assignments

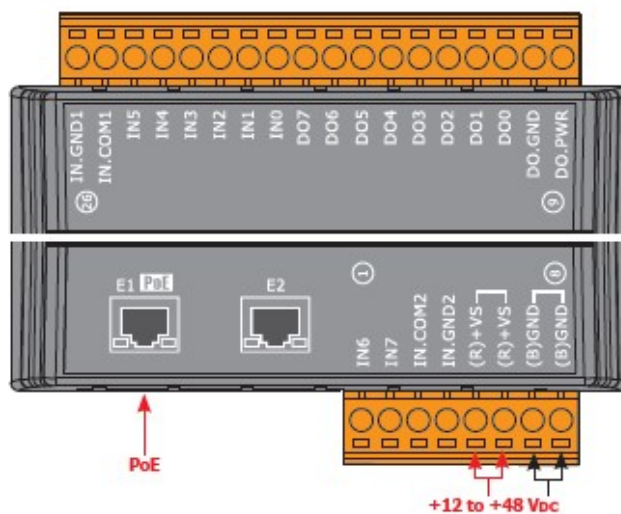

Figure 20 1-5-18 U-7555M Wire Connections / Pin Assignments

1.5.19 U-7558M Wire Connections/Pin Assignments

Wire Connections

Digital Input/Counter	ON State Readback as 1 80 ~ 250 VAC	OFF State Readback as 0 OPEN or < 30 VAC Max.
AC Digital Input		
DC Digital Input		

Pin Assignments

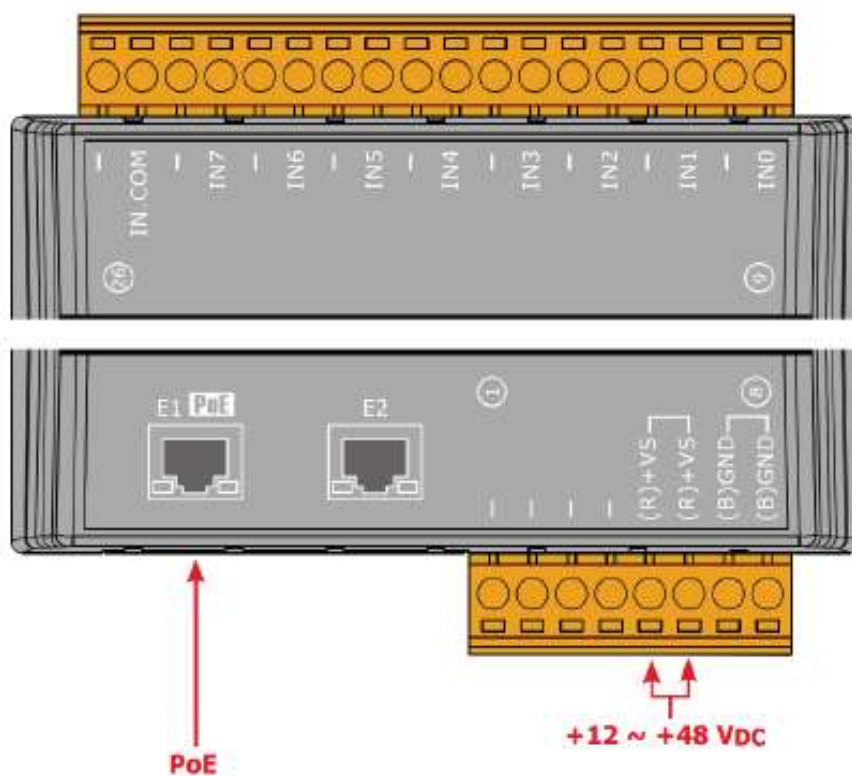

Figure 21 1-5-19 U-7558M Wire Connections/Pin Assignments

1.5.20 U-7559M Wire Connections/Pin Assignments

Wire Connections

Digital Input/Counter	ON State Readback as 1 10 ~ 80 VAC	OFF State Readback as 0 OPEN or < 3 VAC Max.
AC Digital Input		
DC Digital Input		

Pin Assignments

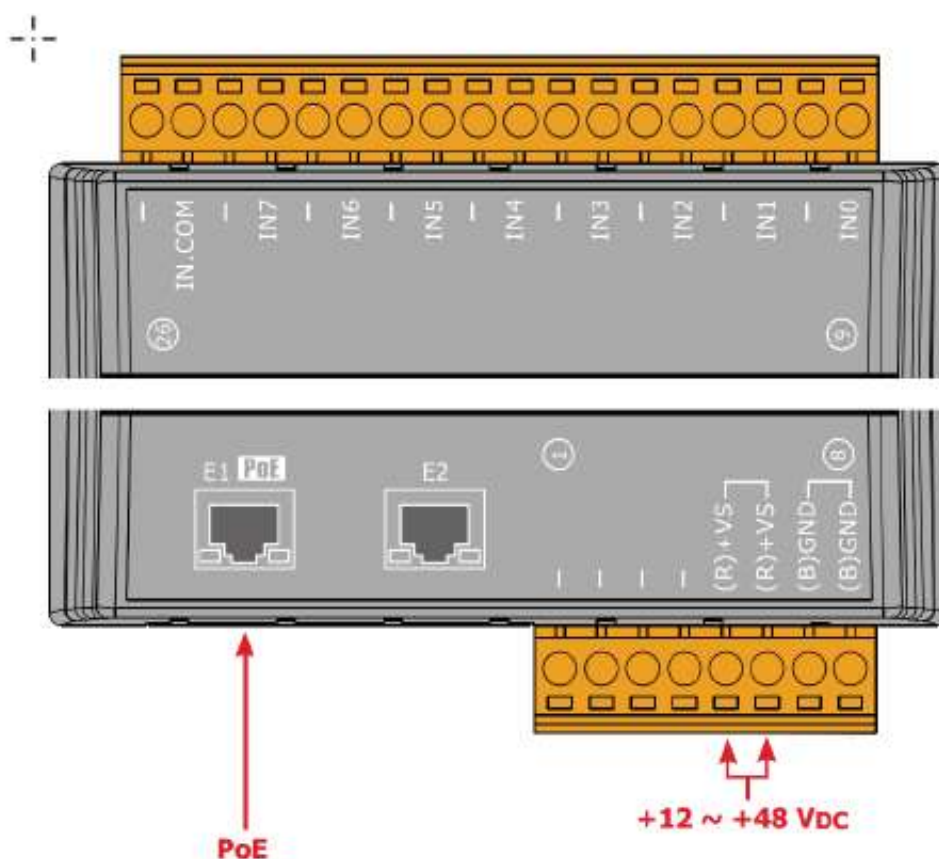
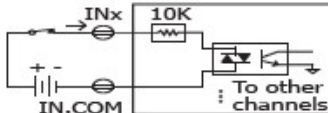
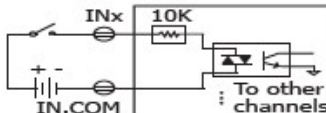
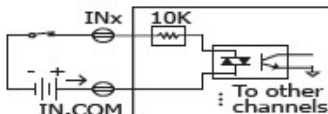
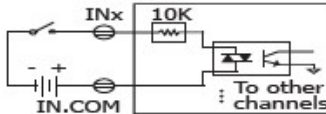
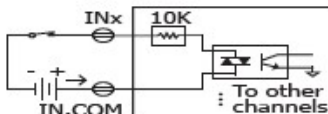
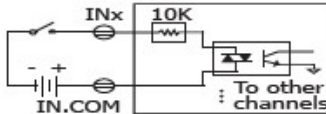
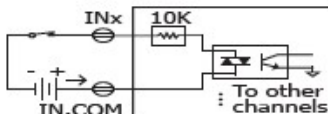
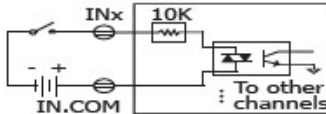
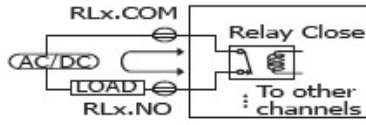
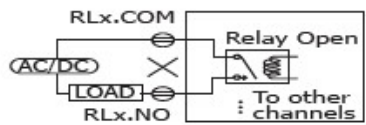

Figure 22 1-5-20 U-7559M Wire Connections/Pin Assignments

1.5.21 U-7560M Wire Connections / Pin Assignments

Wire Connections

Digital Input/Counter	Readback as 1	Readback as 0
Sink	+10 ~ +50 Vdc 	OPEN or <4 Vdc 
	+10 ~ +50 Vdc 	OPEN or <4 Vdc 
Source	+10 ~ +50 Vdc 	OPEN or <4 Vdc 
	+10 ~ +50 Vdc 	OPEN or <4 Vdc 

Power Relay	ON State: Readback as 1
Relay Output	
	OFF State: Readback as 0 

Pin Assignments

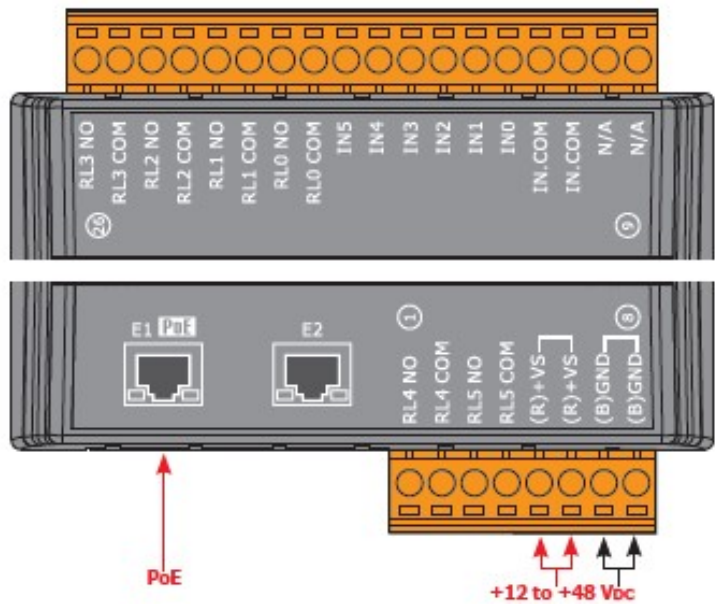
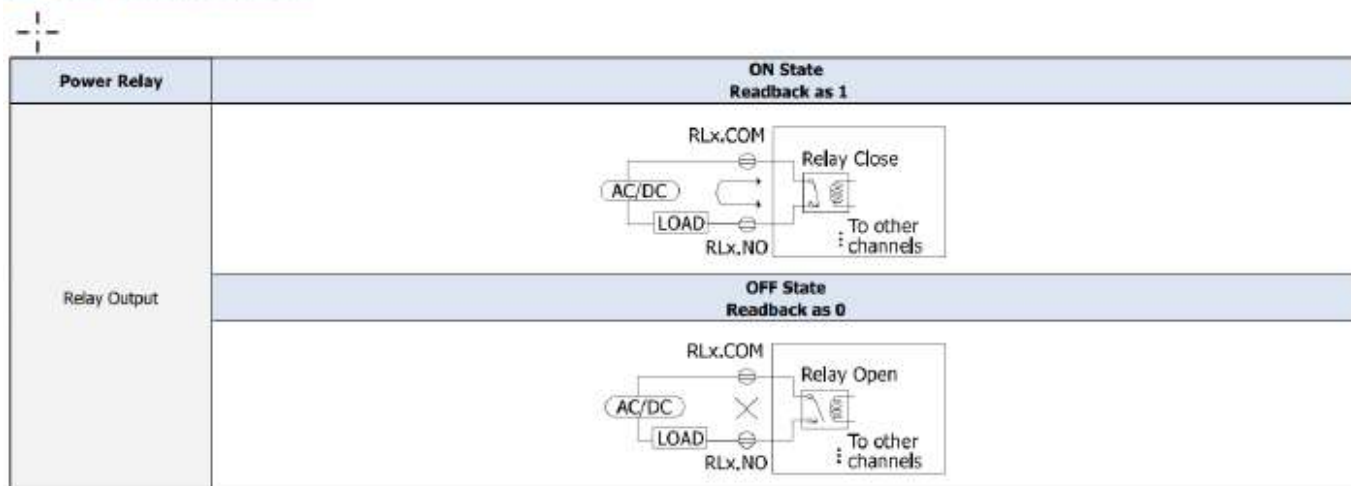

Figure 23 1-5-21 U-7560M Wire Connections / Pin Assignments

1.5.22 U-7561M Wire Connections/Pin Assignments

Wire Connections



Pin Assignments

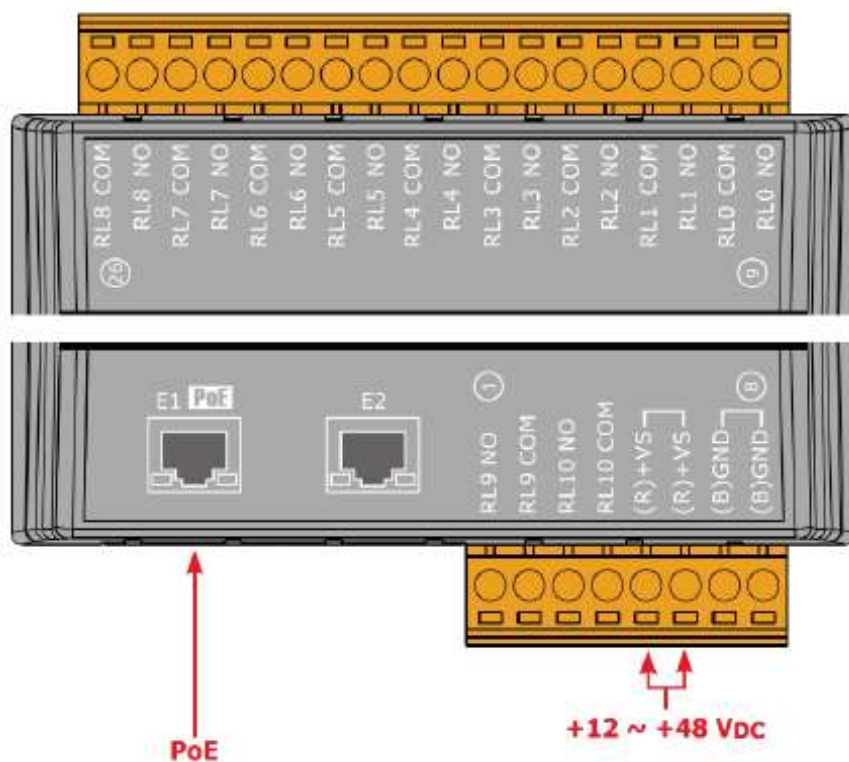
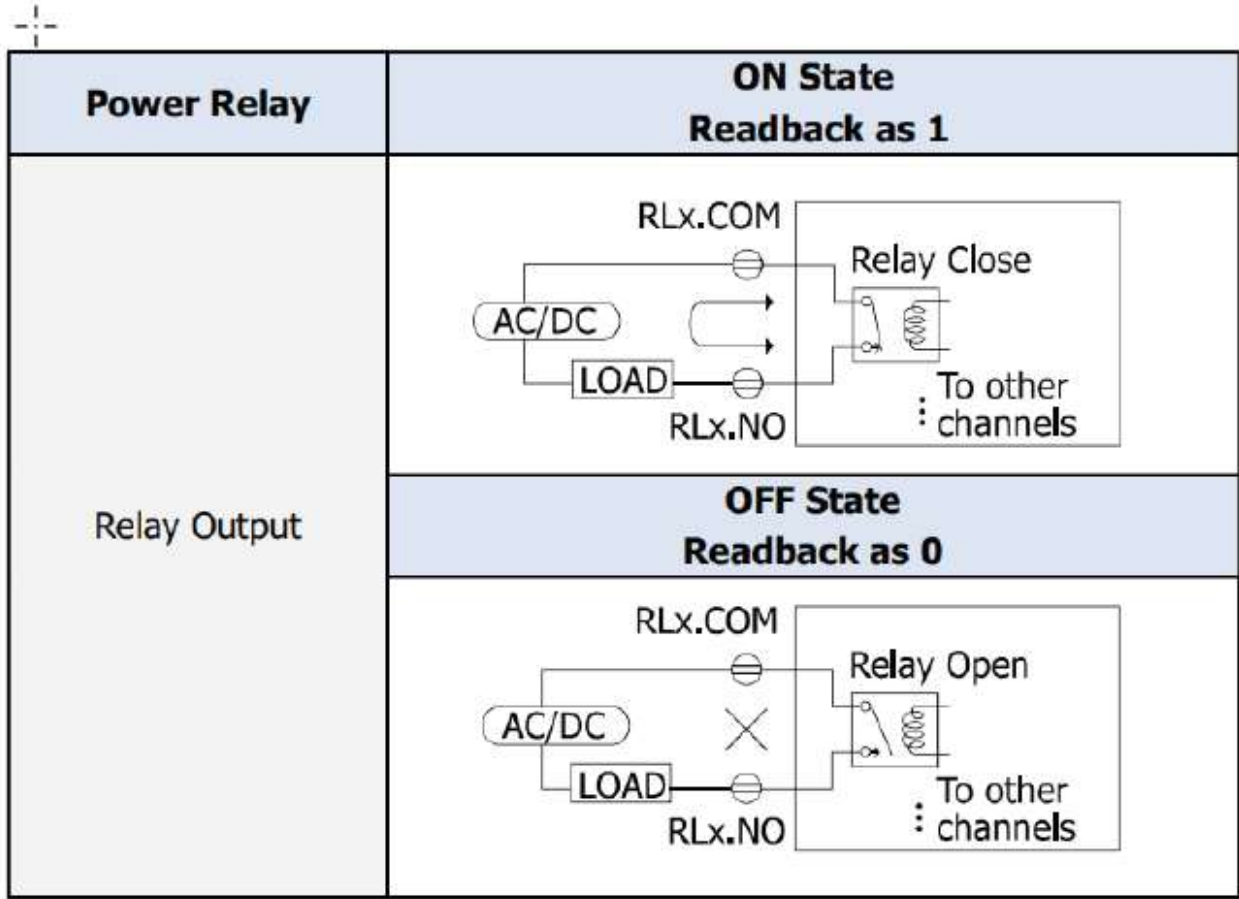

Figure 24 1-5-22 U-7561M Wire Connections/Pin Assignments

1.5.23 U-7567M Wire Connections/Pin Assignments

Wire Connections



Pin Assignments

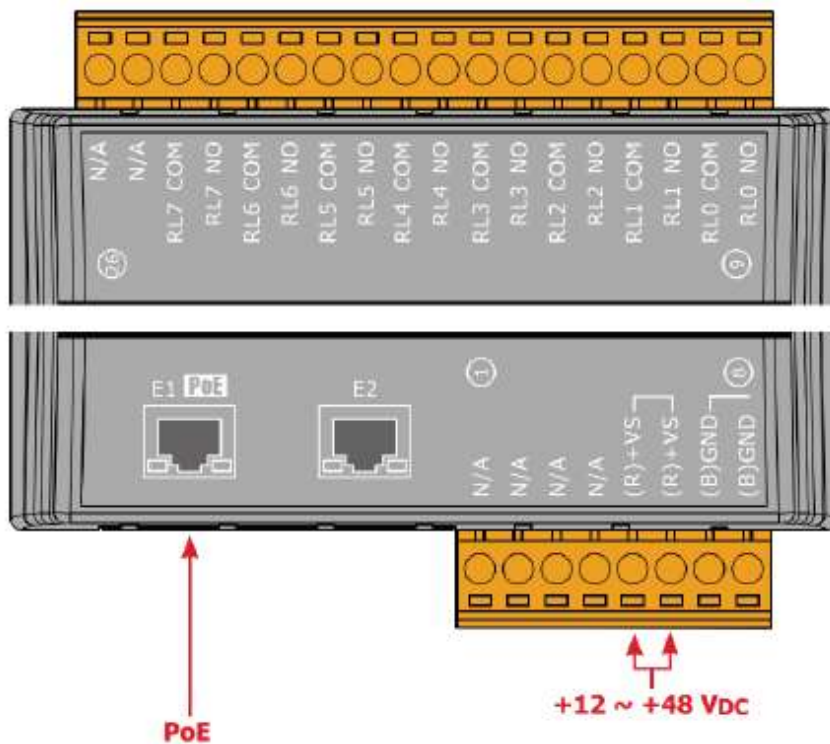

Figure 25 1-5-23 U-7567M Wire Connections/Pin Assignments

1.6 Dimensions

U-7502M/U-7504M/U-7515M/U-7517M/U-7517M-10/U-7524M /U-7526M/U-7528M/U-7542M/U-7544M/U-7545M/U-7550AM /U-7551M/U-7552M/U-7553M/U-7555M/U-7558M/U-7559M /U-7560M/U-7561M/U-7567M Dimensions

(Unit: mm)

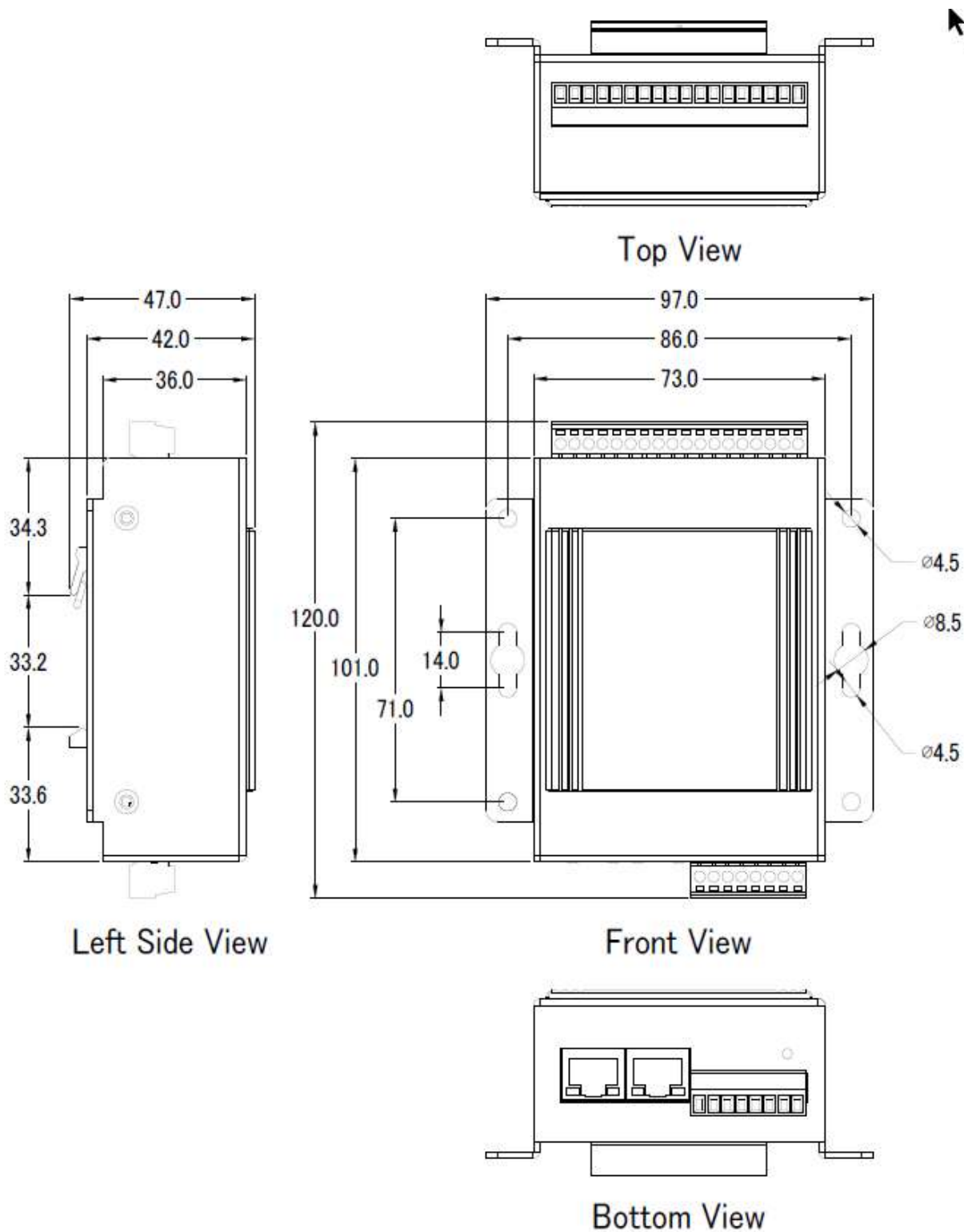

Figure 26 1-6 Dimensions

U-7518ZM/U-7519ZM Dimensions

(Unit: mm)

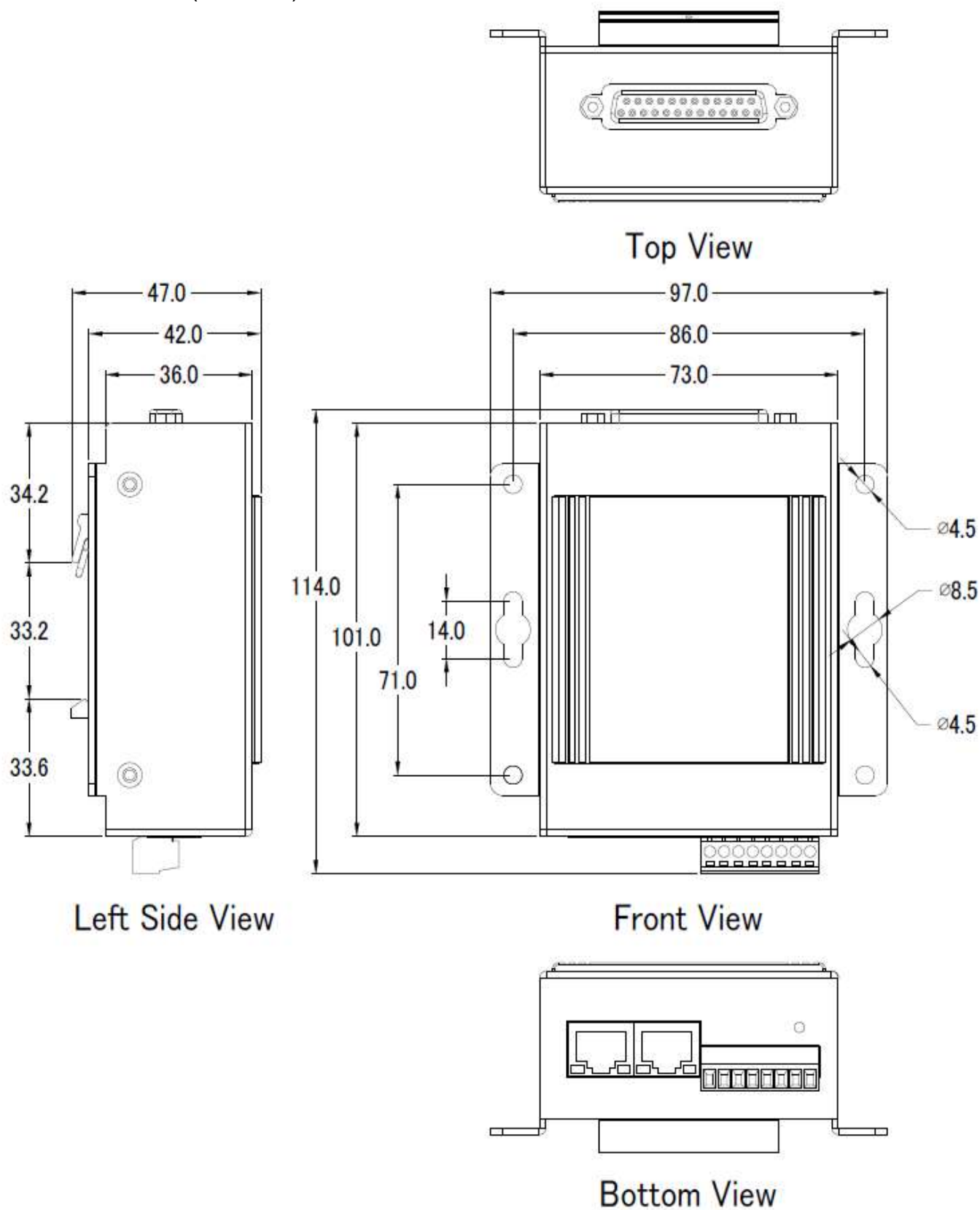

Figure 27 1-6 U-7518ZM/U-7519ZM Dimensions

2. Quick Start: Hardware/Network Connection

This chapter describes the UA I/O module’s hardware connection, network connection and quick setting. For how to set up a project via the Web UI on the browser, please refer to Chapter 3.

2.1. Hardware Connection

This section describes the hardware wiring and connection for the UA I/O module.

2.1.1. Preparations for Devices

In addition to the UA I/O modules (Ex: U-7555M), please prepare the following:

1. **PC/NB:** Can connect to the network and set the network
2. **Ethernet Switch/Hub:** e.g. NS-205 or **PoE Switch** NSM-208SE
3. **Power Supply:** +12 ~ +48 VDC, e.g. MDR-60-24 (If using PoE Switch, user can save a power supply.)

2.1.2. AI/AO Jumper Setting

This section is for setting the AI/AO jumpers, take U-7504M, U-7526M for example, if use DI/O module, please go to the next section.

Setting the Selection Jumpers for Analog channels:

1. **Disconnect the power, remove the top case and upper board** of the module if need to change the selection jumper, the selection jumpers are next to the connector.
2. Set up the **Jumper** corresponding to the type of **voltage/current and input/output** for each analog channel.

Voltage/Current Input/output Selection Jumper: (Default as AI/AO: Voltage/Voltage)

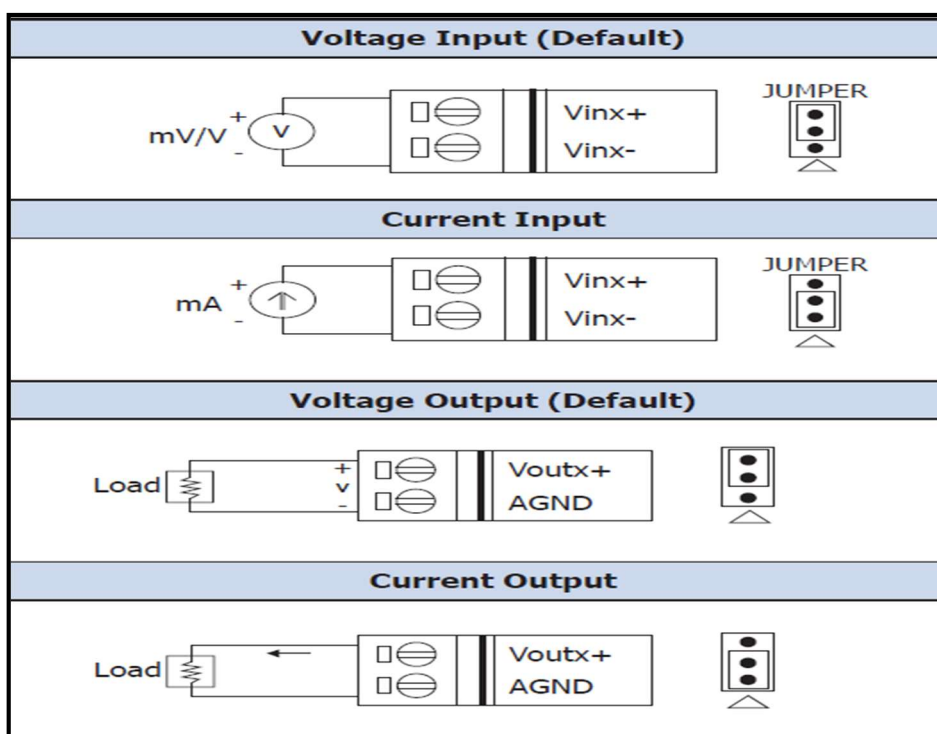

Figure 28 2-1-2 Voltage/Current Input/output Selection Jumper

Jumper Location:

U-7504M								
Channel	Vin3	Vin2	Vin1	Vin0	Vout3	Vout2	Vout1	Vout0
Jumper	J4	J3	J2	J1	J8	J7	J6	J5

U-7526M								
Channel	Vout1	Vout0	Vin5	Vin4	Vin3	Vin2	Vin1	Vin0
Jumper	J8	J7	J6	J5	J4	J3	J2	J1

Jumper Direction 

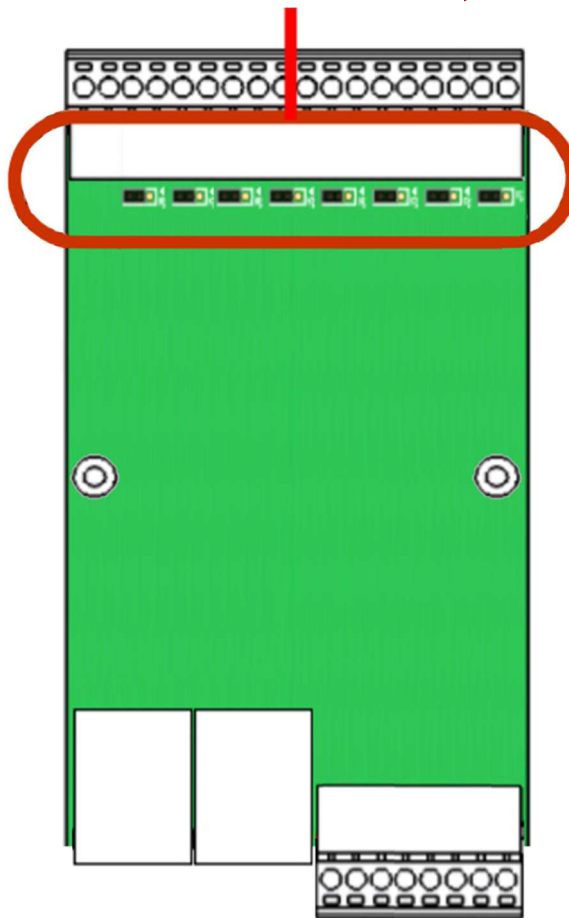

(Jumpers default as:
 Input: Voltage
 Output: Voltage.

 If you need to change the
 jumpers, remove the top case
 and upper board first.)

2.1.3. Hardware Wiring

Connect the U-7500 I/O Module with the RJ-45 Ethernet port to an Ethernet switch/hub and PC (**Fig.1**). Beside, U-7500 support PoE (Power over Ethernet). If using the PoE switch, do not need one more power supply (**Fig.2 for PoE Switch**). You can also directly link the U-7500 to the PC with an Ethernet cable.

After power is connected, please **【wait 1 minute】** for U-7500 start-up procedure. When the "RUN" light starts operating, it represents the boot is complete. **(After a minute, the "RUN" light flashes at one-second intervals, showing that the contact of the SD card in the module is abnormal.)**

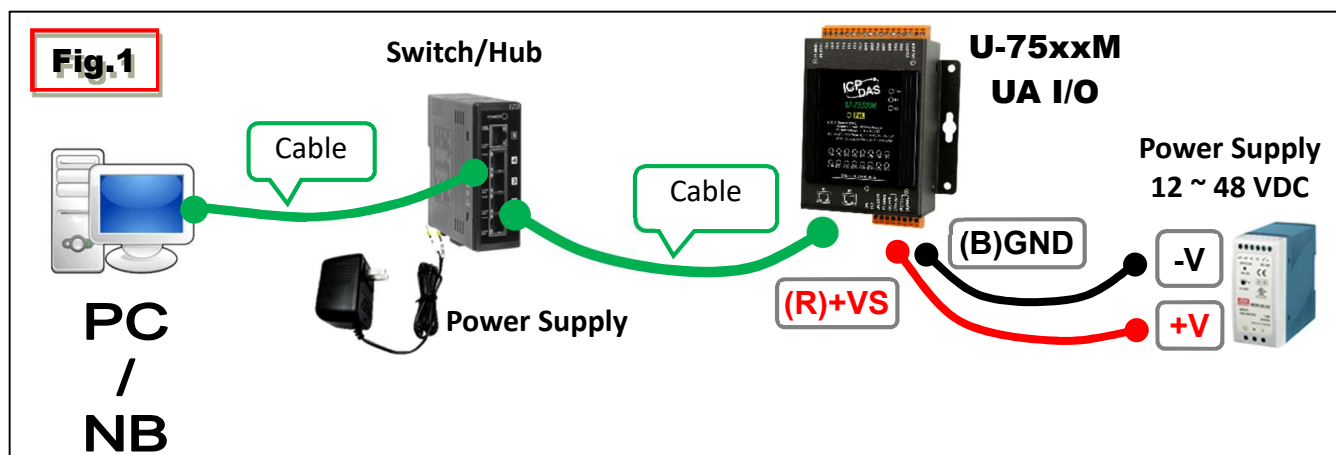

Figure 29 2-1-3 Hardware Wiring(Fig.1)

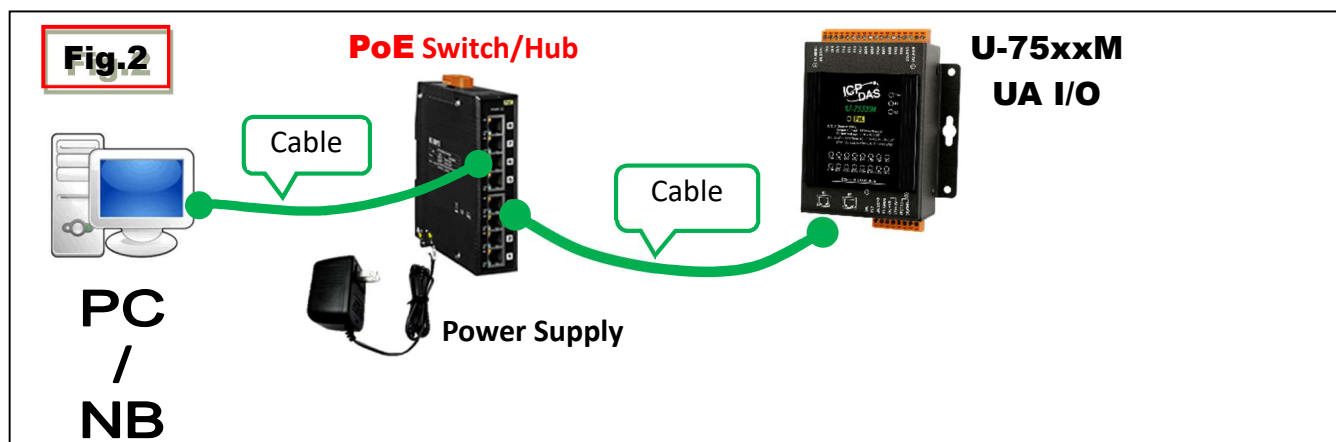

Figure 30 2-1-3 Hardware Wiring(Fig.2)

2.2. Network Connection

This section introduces 3 methods to connect to the **UA I/O Web UI** (User Interface).

Setting **new UA I/O module or the new user** please uses **method A** in **Chapter 2.2.1** (The same method as the “UA I/O Quick Start” document.). Other users, please see the following introductions to choose method B or C.

The methods to login the UA I/O Web UI:

A. Using Factory Default Setting:

Suitable for setting a new UA I/O module and the PC network IP is not in the same domain with UA I/O. This method changes the PC network IP to be the same domain with the network IP of the UA I/O factory default values to login the Web UI. (Refer [Chapter 2.2.1](#))

B. Using Software Utility:

Suitable for quick setting when many UA I/O are in the network but the IP are unknown. UA products provide a free software utility for auto searching UA products in the network and can quick jump to the login web page of UA. (Refer [Chapter 2.2.2](#))

C. Using IP Address:

Suitable for the UA has a fixed IP and in the same domain with the PC. If the UA has a fixed IP and in the same domain with the PC, users can directly enter the IP in the address bar of a web browser and log in to the Web UI of the UA. After login the UA I/O Web UI, then can set up the UA project.

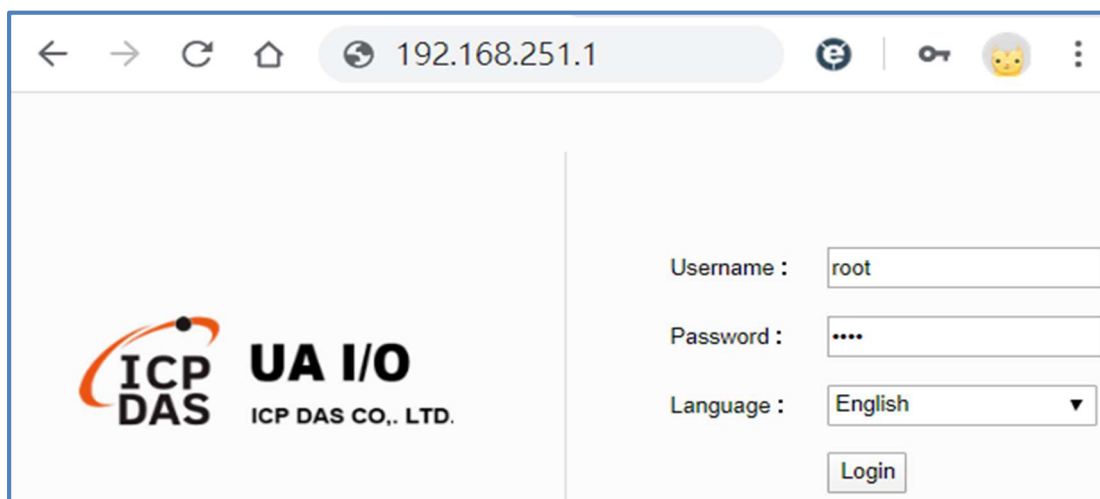

Figure 31 2-2 Use IP to login to UA I/O Web UI Web UI

2.2.1. Connection by Factory Default Settings (For New UA)

The factory default settings of the UA I/O series are as the following table:

Table 27 2-2-1 Factory Default Settings of UA I/O Modules (1)

Factory Default Settings of UA I/O Modules			
Network	IP	192.168.255.1	Assign U-7500 a new IP setting according to your case.
	Mask	255.255.0.0	
	Gateway	192.168.1.1	
Web UI Account	Username	root	After the first login, change the default username/password to use other functions.
	Password	root	

1. Change the PC's IP setting as following. (**Write down the PC original network settings before modify.**)

Table 28 2-2-1 Factory Default Settings of UA I/O Modules (2)

IP	192.168.255.10
Subnet mask	255.255.0.0
Default gateway	192.168.1.1

2. Make sure the PC and UA I/O is connecting through Ethernet. Then open a PC side browser (Ex: Chrome, IE...).

Type `http://192.168.255.1` in the URL address. Use Web UI default username / password "root" / "root" to login the system.

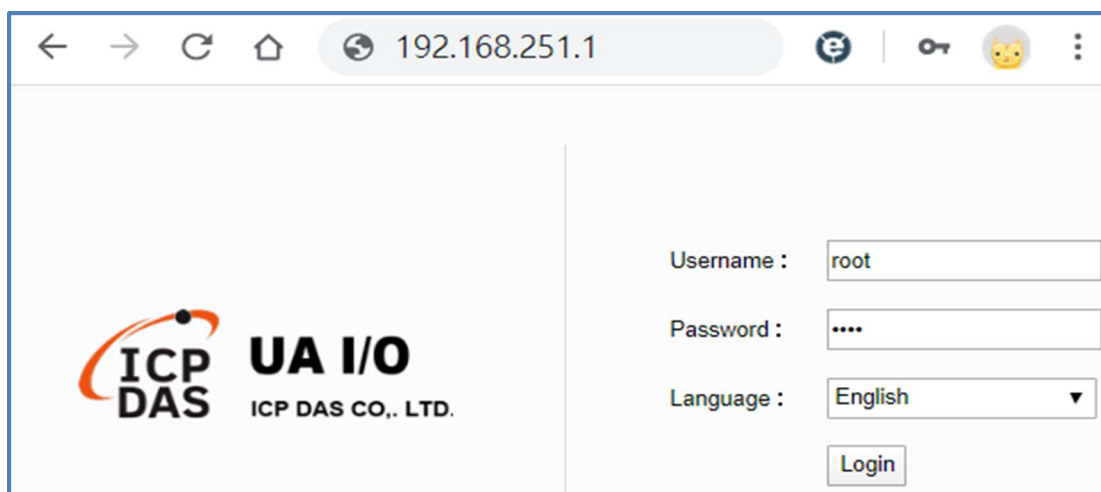

Figure 32 2-2-1 Use root/ root to login to UA I/O Web UI

3. Click 【System Setting】 → 【Account Setting】 , change the Username/password first, or user cannot use any other function (New design for data security).

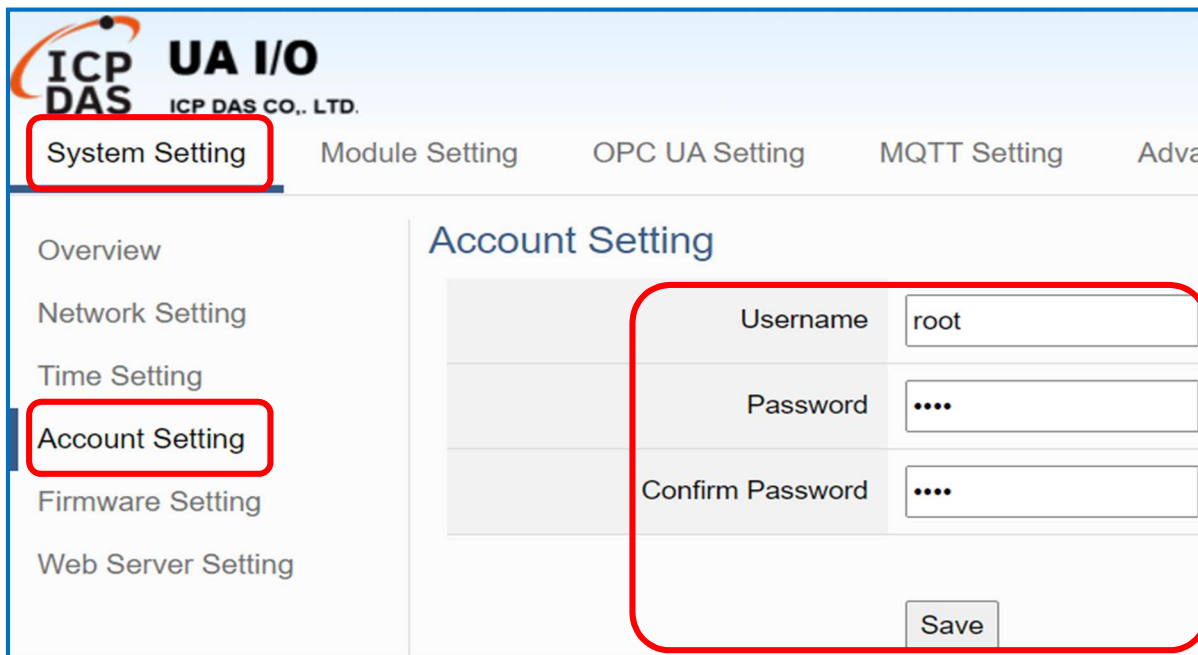

Figure 33 2-2-1 Change the Username/password

Password Setting rules:

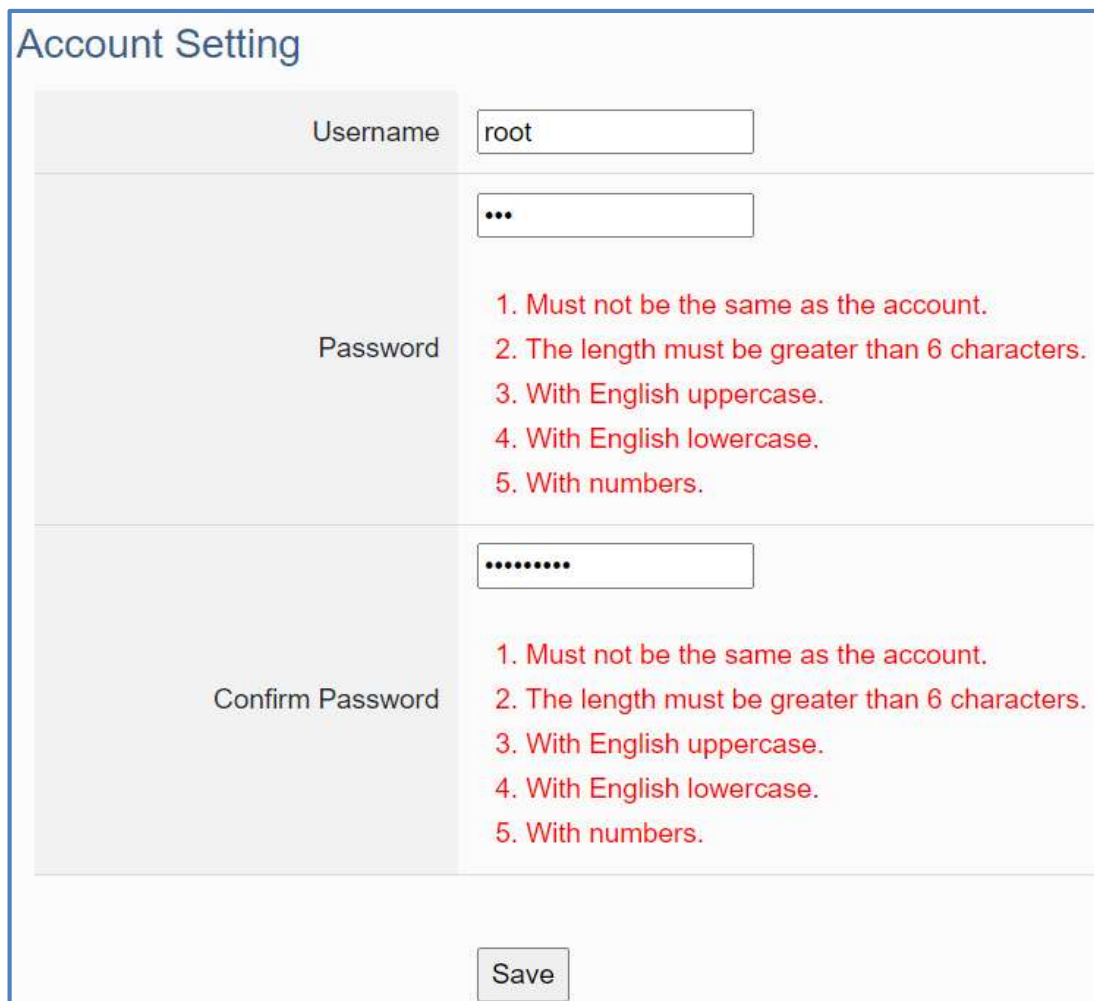

Figure 34 2-2-1 Password Setting Rules

- Click **【System Setting】** → **【Network Setting】** → **【Network Setting(LAN1)】** to change the IP setting by user network.

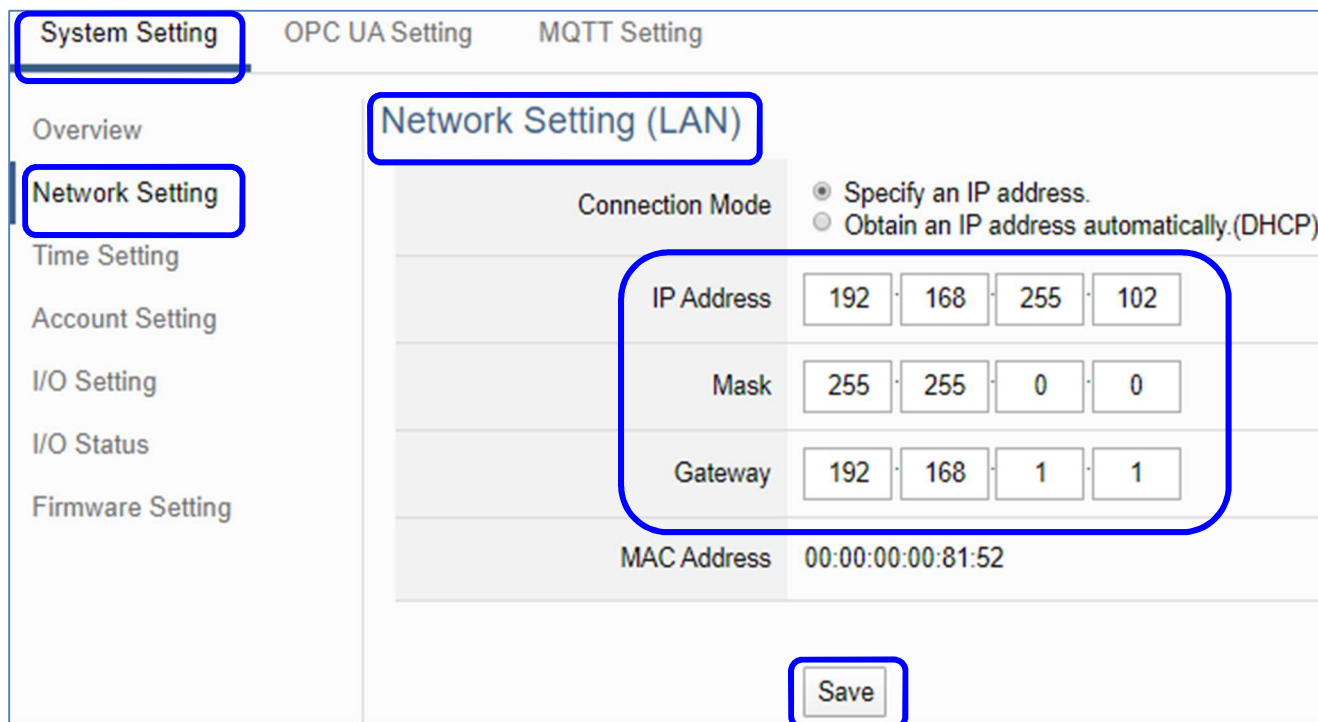

Figure 35 2-2-1 Network Setting(LAN1)

- Save the IP setting, restore the PC original IP settings, and type the new IP in the browser as step-2 to login the Web UI of UA I/O. Then configure user’s UA project.



Figure 36 2-2-1 Use the new IP to login the Web UI of UA I/O

After setting, you can enter the IP address of the UA in the browser's URL bar and connect to the network interface to set up the UA.

2.2.2. Connection by Utility Searching

Setting new UA I/O or the new user please uses the method in the [Chapter 2.2.1](#). (A)

If the UA I/O has a fixed IP and in the same domain as the PC, users can directly enter the IP in the address bar of a web browser and log in to the Web UI of the UA.I/O (C)

This section introduces the 2nd method(B) that users use the UA I/O Utility to search the Network IP. This method is suitable for connecting multiple UA I/O series modules to the Internet, but the IP addresses of UA I/O are unknown or need to modify the UA I/O quickly.

The Utility is a free tool software to quickly search each UA/BRK/UA_IO series on the network and connect to its Web UI for setting UA/BRK/UA_IO series products and projects.

In the PC, download and install the Utility (EZ-UAQ Utility) suitable for your PC, and then run it to connect the device. Please download the utility program from the website:

<https://www.icpdas.com/en/download/show.php?num=8560&nation=US&kind1=&model=&kw=u-7>

FILE NAME	VERSION	FILE DATE	SIZE	NOTE
EZ-UAQ Utility-Framework3.5	v1.1.1	2023-03-29	1.68 MB	
EZ-UAQ Utility-Framework4.7	v1.1.1	2023-03-29	1.68 MB	

Figure 37 2-2-2 Download and install the Utility (EZ-UAQ Utility)

1. Install and execute the Utility
 Download and unzip the Utility, double-click the executable file (EZ-UAQ Utility.msi) to install and execute the Utility software.
 (If there is an old version of Utility on the PC, please uninstall it first.)

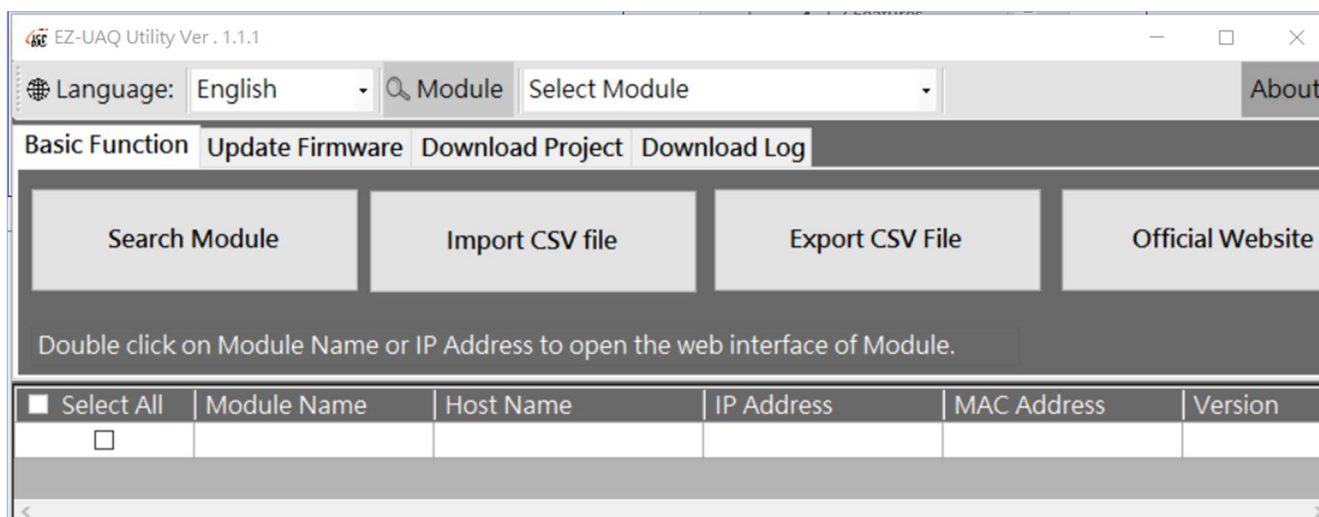

Figure 38 2-2-2 EZ-UAQ Utility Web Interface

- Search the UA/BRK/UA_IO series modules
Click the “**Search Module**” button the utility will search and list all UA/BRK/UA_IO modules in the network.

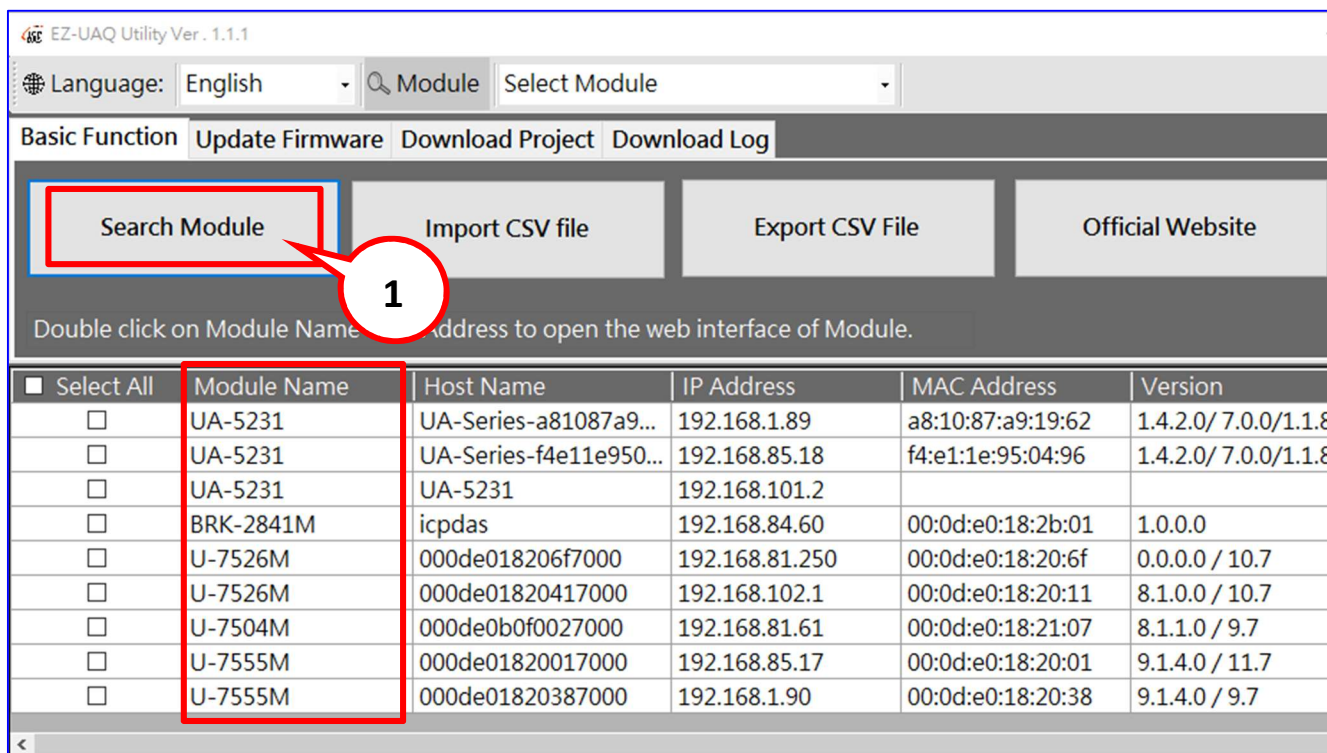

Figure 39 2-2-2 2 Search the UA/BRK/UA_IO series modules

3. Connect to the UA I/O Series

Double click the module list (from the Module Name to the IP address) you want to connect to, and it will directly link to the UA/BRK/UA_IO webpage via the default Web browser (Chrome, Edge, IE...).

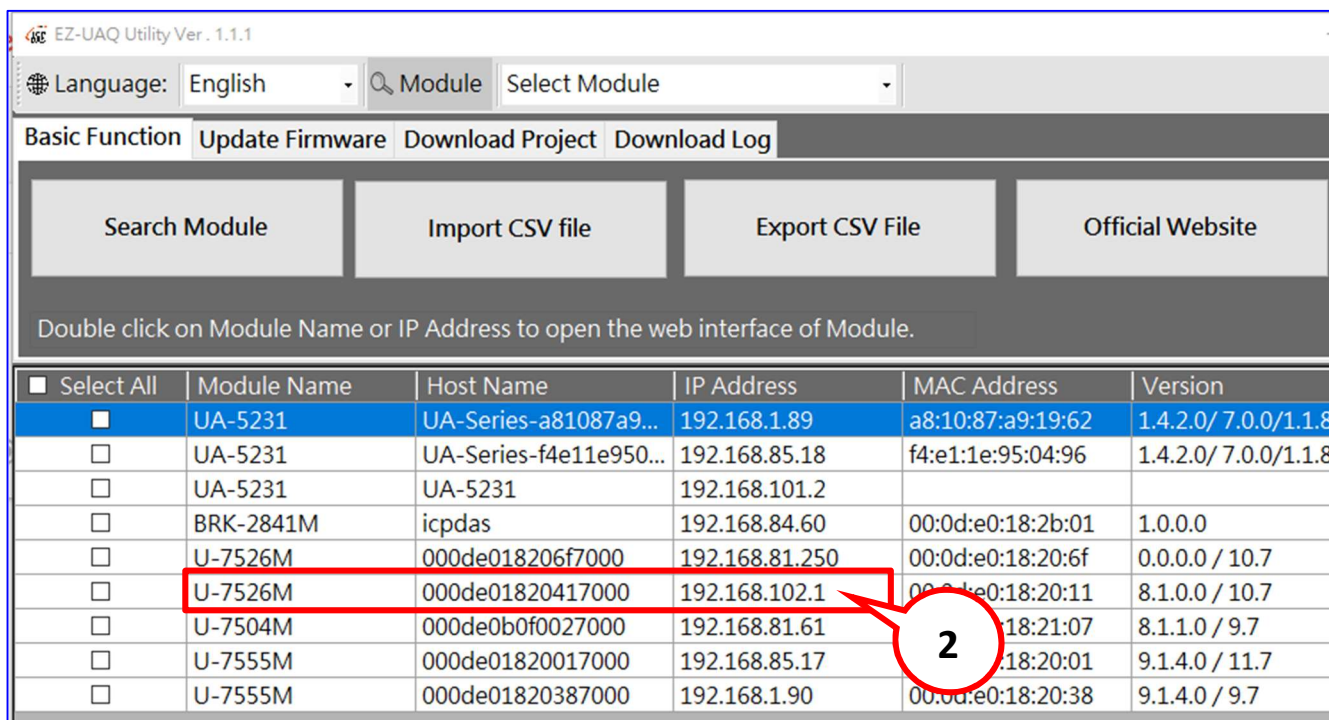

Figure 40 2-2-2 3 Connect to the UA I/O Series

4. Connection to the UA I/O Web UI

The default web browser will be run and direct go to the UA login web site. Please enter the username and password to login the UA I/O series Web UI.

The factory default username: root. The factory default password: root. After login in, change the default Username/password first, or user cannot use any other function (New design for data security).

Figure 41 2-2-2 Connection to the UA I/O Web UI

5. Login the Web UI of the UA I/O Series

When login into the web interface, the UA I/O default home page (the main configuration screen) will as below, and will automatically read setting of that UA I/O to the webpage.

Firmware Version	9.0.0.0
Factory Version	12.7
MAC Address	00:0d:e0:18:20:6f

Component	Usage Rate (%)
CPU	~15
Memory	~65
Disk	~55

Figure 42 2-2-2 Login the Web UI of the UA I/O Series

3. Main Function Settings

This chapter introduces some of the most important and commonly used functions of UA I/O and their setting steps.

OPC UA I/O modules is a series of Ethernet I/O modules that built-in with the **OPC UA Server / Client, MQTT Client and RESTful API services**. The OPC UA I/O module, also called UA I/O or U-7500, supports the OPC UA Server, MQTT Client and RESTful API function in industrial networking communication. Users can choose the networking mode according to their needs and environment, to transmit the values of built-in I/O channels to the cloud IT system or field control system for reading and writing. So, the main functions are the OPC UA connection and the MQTT connection. This chapter will introduce them first. Each function can be divided into the settings for the Server/Broker and Client, and how to enable secure encrypted communication, and how to download/upload the secure certificates. In addition, the AI/AO, DI/DO function applications are also very important for the UA I/O, which will be added to this chapter soon.

OPC UA / MQTT Communication Advantages: (V.S. traditional Modbus Communication)

Support Identity Authentication

Identity Authentication			
ICP DAS UA Solution	OPC UA	ID/Password, Anonymous, Certificate	Yes
	MQTT	ID/Password, Anonymous	
Traditional	Modbus	None	

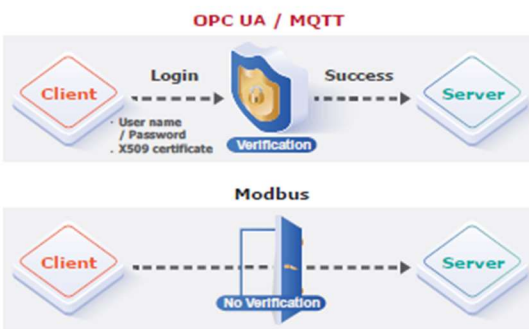

Support Data Encryption

Data Encryption			
ICP DAS UA Solution	OPC UA	SSL/TLS Encryption	Yes
	MQTT	SSL/TLS Encryption	
Traditional	Modbus	None	

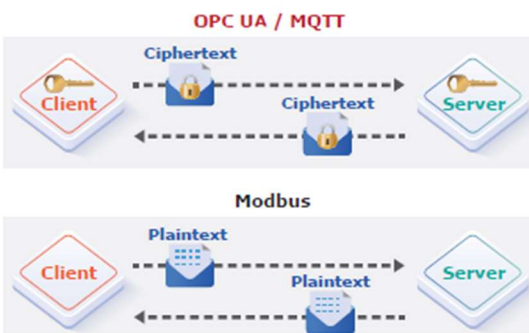

Active Data Transmission

Data Transmission			
ICP DAS UA Solution	OPC UA	Active (Server sends Data to the Client)	Active
	MQTT	Active (Client publishes Data to Broker, and the Broker sends Data to other Clients)	
Traditional	Modbus	Passive (Request/Response (Wait for Master to poll the Data))	

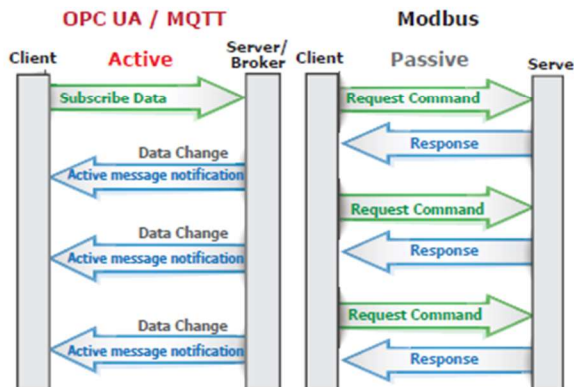

Figure 43 3 OPC UA / MQTT Communication Advantages

3.1 Settings for Using OPC UA Connection

This section introduces how to set up the OPC UA communication service of UA I/O, and recommends compatible ICP DAS products.

UA I/O module built-in OPC UA Server Service that compliance with IEC 62541 Standard. Provides functions of Active Transmission, Transmission Security Encryption (SSL/TLS), User Authentication (X.509 Certificates / Account password), Communication Error Detection and Recovery, etc. to connect SCADA or OPC UA Clients. Recommend to keep the maximum number of sessions within 3 connections.

OPC UA connection includes the following settings that will be introduced in 3 sub-sections.

1. OPC UA Server Connection Settings (UA I/O)
2. OPC UA Client I/O Settings (Recommend to use the AVEVA Edge/ InduSoft product of ICP DAS.)
3. How to enable secure encrypted function, and download/upload the encrypted certificates

OPC UA Architecture and Advantages of the UA I/O:

OPC UA Architecture

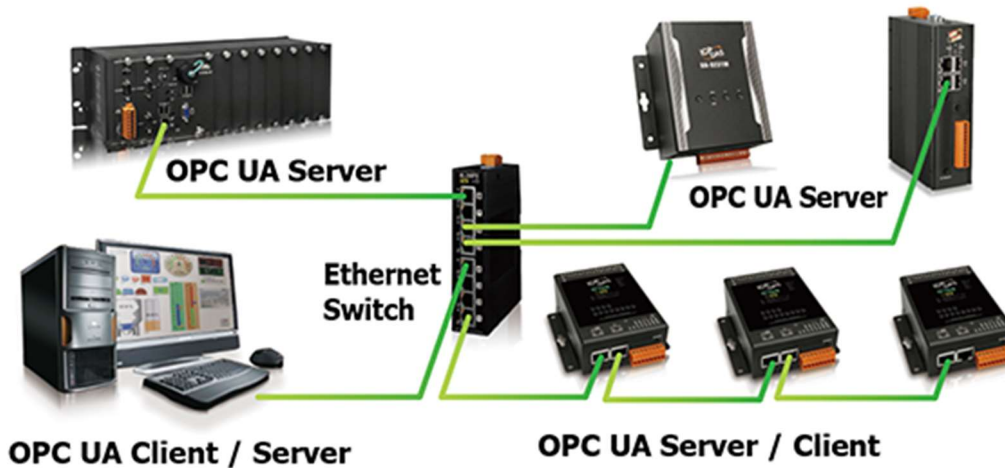

Comparison: ICP DAS UA I/O Module v.s. Traditional I/O Module

Item	ICP DAS UA I/O Module		Traditional I/O Module
Protocol	OPC UA Server / Client	MQTT Client	Modbus TCP Slave
Identity Authentication	Account ID/Password, Anonymous, Certificate Verification	Account ID/Password, Anonymous, Certificate Verification	None
Encryption	SSL/TLS, Anonymous	SSL/TLS, Anonymous	None
Data Transmission	Active (Actively sends Data to the Client)	Active (Actively publishes Data to Broker, and the Broker sends Data to other Clients)	Passive (Wait for Master to poll the Data: Query/Response)
Project Building	Via browse the Server Content	Via subscribe Topic from Broker	Manually assign an ID and define the Data address and type.

Figure 44 3-1 OPC UA Architecture and Advantages of the UA I/O

3.1.1 OPC UA Server Connection Settings (UA I/O)

UA I/O module built-in OPC UA Server function and itself is the Server side of the connection. So, when setting up the Server, you only need to set the connection port number and choose the login method (via anonymous, username, or certificate). Usually, the user will enable the username login method, so the user can set the username/password of the account besides.

1. Connection Setting

Click Main Menu 【OPC UA Setting】 → 【Server Setting】 → 【Connection Setting】 .

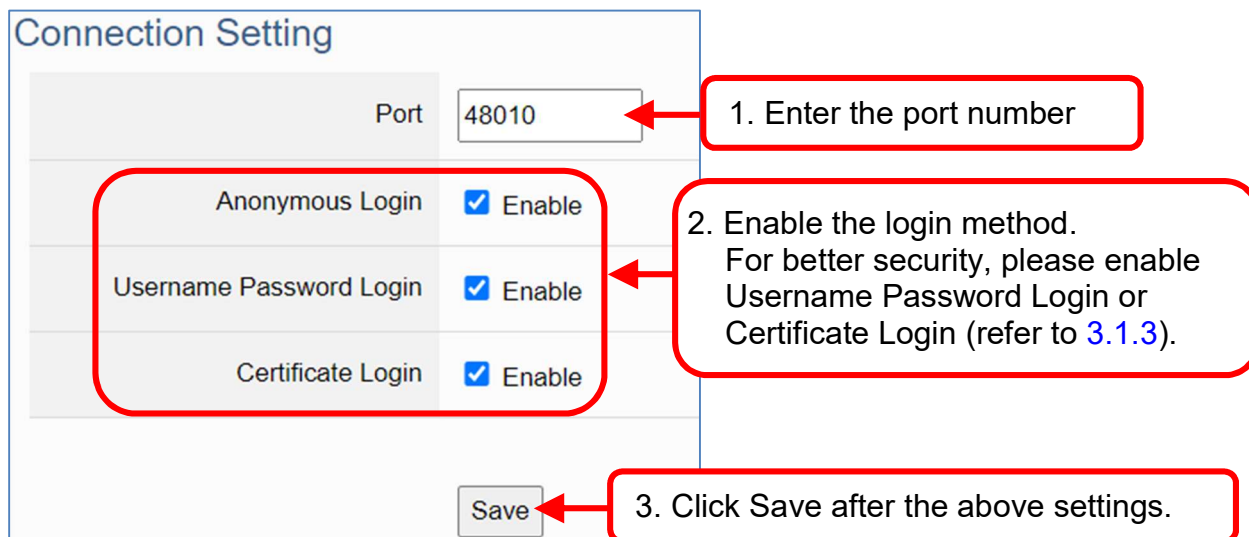

Figure 45 3-1-1 OPC UA Server Connection Setting (UA I/O)

2. When enabling username password login, please set the account in the following menu path.

Menu Path: 【System Setting】 → 【Account Setting】 System Setting → Account Setting (Appendix A).

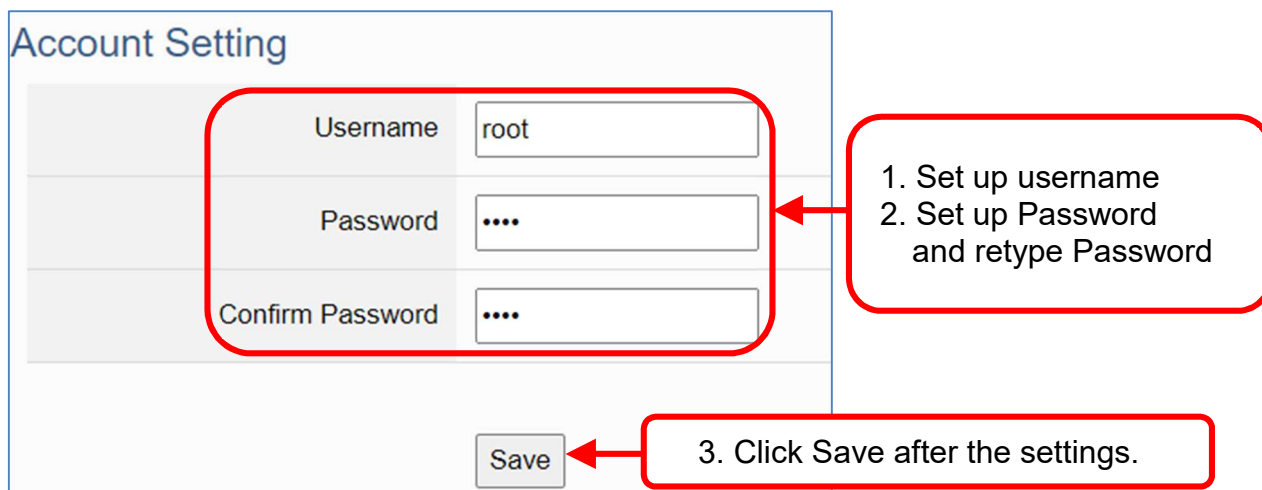

Figure 46 3-1-1 OPC UA Server Account Setting (UA I/O)

If users enable the secure and encrypted OPC UA **Certificate Login** and need to upload/download certificates, please refer to [Sec.3.1.3](#) .

After completing the Server connection settings, then set the **Client connection** (refer to [Sec.3.1.2](#)), and then can communicate with each other.

3.1.2 OPC UA Client Side: AVEVA Edge Simple Application

After setting the OPC UA Server-side (UA I/O), you only need to configure the OPC UA Client for connection. Now, go to the Client device that connects with UA I/O, and set the corresponding data point. We recommend using ICP DAS InduSoft products as the Client device. It is easier to set up relatively and can connect to UA I/O faster. For detailed settings, please refer to UA I/O FAQ-Dev-001.

The setting screen is as follows:

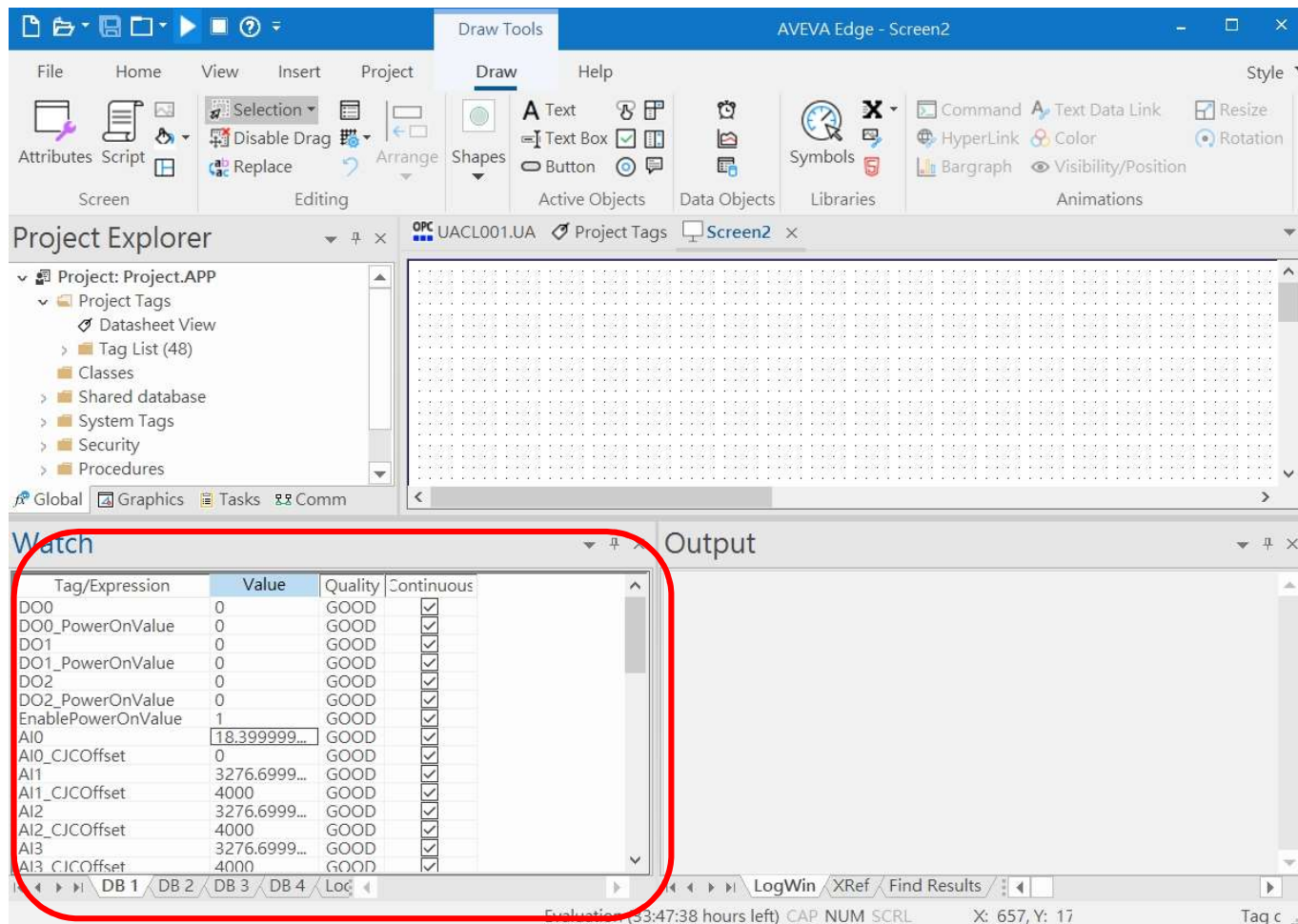



Figure 47 3-1-2 OPC UA Client Side: AVEVA Edge Simple Application

3.1.3 Secure Encrypted Connection: OPC UA Certificate

When using the OPC UA connection, in addition to the account login for security, users can also enable the certificate login to double the protection by the secure encryption. This section describes how to download/upload the certificates. If you do not want to enable the certificate login, please skip.

When enabling the OPC UA certificate login, the Server/Client both sides of the connection need to add certificates to each other's trust zones. This section will show how to do the steps.

Menu Path: 【OPC UA Setting】 → 【Certificate】 →  →  (Appendix A).

- A. **Provide the OPC UA Server Certificate of the UA I/O** to the Client device. That is, download the Server certificate file of the UA I/O, and then upload and import it into the software (or APP) of the OPC UA Client device.

Click the "Download" button to get the Certificate file generated by the Server.
File Name: icpdasuaserver.der

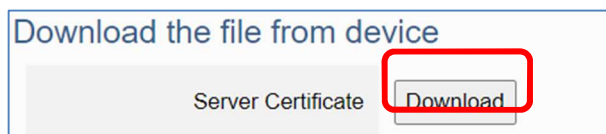

Figure 48 3-1-3 Download the file from device(1)

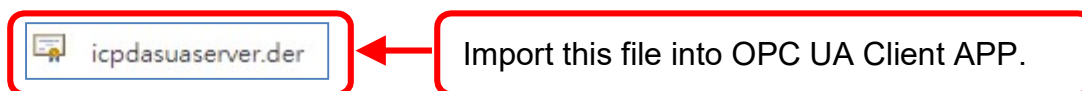

Figure 49 3-1-3 Download the file from device(2)

- B. **Get the Trusted Certificate file of the connected OPC UA Client**, save it in the PC, and upload it into the UA I/O module.

- 1) Click the "Upload" button to open the "open" window.

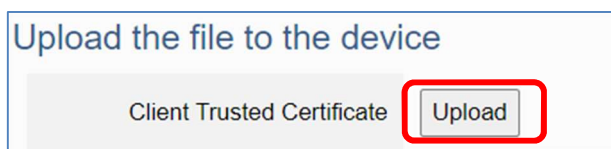

Figure 50 3-1-3 Upload the file to the device(1)

- 2) Select the Trusted Certificate file.

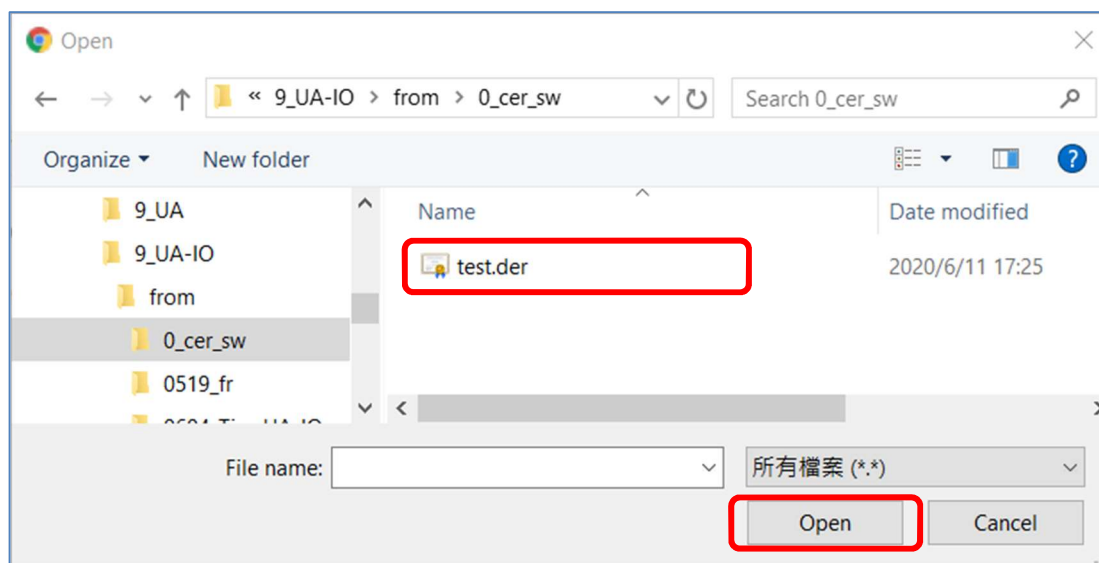

Figure 51 3-1-3 Upload the file to the device(2)

3.2 Settings for Using MQTT Connection

This section introduces how to set up the MQTT Client communication of UA I/O, and recommends the compatible ICP DAS products.

UA I/O module built-in MQTT Client Service (Compliance with MQTT V.3.1.1 protocol). Provides functions of IoT Active M2M Transmission, QoS (Quality of Service), Retains Mechanism, Identity Authentication, Encryption, Last Will, etc.

MQTT connection includes the following settings that will be introduced in 3 sub-sections.

1. MQTT Broker Connection Settings (Recommend the UA-2xxx/52xx & BRK series of ICP DAS)
2. MQTT Client side I/O Settings (UA I/O)
3. How to enable secure encrypted function, and download/upload the encrypted certificates

MQTT Architecture and Advantages of the UA I/O:

MQTT Architecture



Comparison: ICP DAS UA I/O Module v.s. Traditional I/O Module

Item	ICP DAS UA I/O Module		Traditional I/O Module
Protocol	OPC UA Server / Client	MQTT Client	Modbus TCP Slave
Identity Authentication	Account ID/Password, Anonymous, Certificate Verification	Account ID/Password, Anonymous, Certificate Verification	None
Encryption	SSL/TLS, Anonymous	SSL/TLS, Anonymous	None
Data Transmission	Active (Actively sends Data to the Client)	Active (Actively publishes Data to Broker, and the Broker sends Data to other Clients)	Passive (Wait for Master to poll the Data: Query/Response)
Project Building	Via browse the Server Content	Via subscribe Topic from Broker	Manually assign an ID and define the Data address and type.

Figure 52 3-2 Comparison between UA I/O modules and traditional I/O modules

3.2.1 Connecting to MQTT Broker

UA I/O module built-in MQTT Client function and itself is the Client side of the connection. So, when setting up the MQTT Broker, it is to set the data of the remote device (Broker) that the UA I/O module wants to connect. The data includes Broker's IP address, port number, anonymous login, account password login, etc.

MQTT Broker Device: recommend to use ICP DAS IIoT communication server **UA-2200/5200/2600 series** or MQTT Broker **BRK-2600M/5200M series**.

Main Menu: 【 MQTT Setting 】 → 【 Connection Setting 】 MQTT Setting → Connection Setting
 (Appendix A).

The screenshot shows the 'MQTT Broker Connection Setting' interface. It contains several input fields and buttons. Red boxes and arrows highlight specific elements, each with a corresponding numbered instruction:

- 1.** IP address of the remote MQTT Broker that wants to connect. (MQTT Broker: refer UA-2200/5200 & BRK series of ICP DAS)
- 2.** Port number of the remote MQTT Broker
- 3.** Login username and password of the remote MQTT Broker.
- Click the Test button to test whether the connection to the MQTT Broker is successful.
- 4.** Click to save the settings.

The interface fields shown are: IP Address (192.168.1.13), Port (1883), Keepalive (Second) (60), Anonymous Login (checkbox), Username (root), Password (masked), Test Connection (Test button), and Save button. The Test button shows a 'Success' status.

Figure 53 3-2-1 Connecting to MQTT Broker

If users enable the secure and encrypted MQTT **Certificate Login**, need to upload/download certificates, please refer to [Sec.3.2.3](#).

After completing the MQTT Broker connection settings, then set the **Client connection** (refer to [Sec.3.2.2](#)), and then can communicate with each other.

3.2.2 MQTT Client Setting of the UA I/O

UA I/O built-in MQTT Client function and itself is the MQTT Client side of the connect. When setting, please set the connecting remote MQTT Broker device first, and then set the UA I/O module of the MQTT client.

Reference for MQTT related basic knowledge:

MQTT (MQ Telemetry Transport) is a lightweight **publish/subscribe** messaging protocol. An MQTT-based application will include two or **more clients**, which are applications exchanging messages, and **a broker**, which is a server that accepts incoming messages and routes them to the appropriate destination client. As with most *publish-subscribe* systems, message sends involve **publishing** on a specified **topic**. The **broker** then forwards the message to all **subscribers** of that topic. These primitives can be used to build different interaction patterns. (as the picture below)

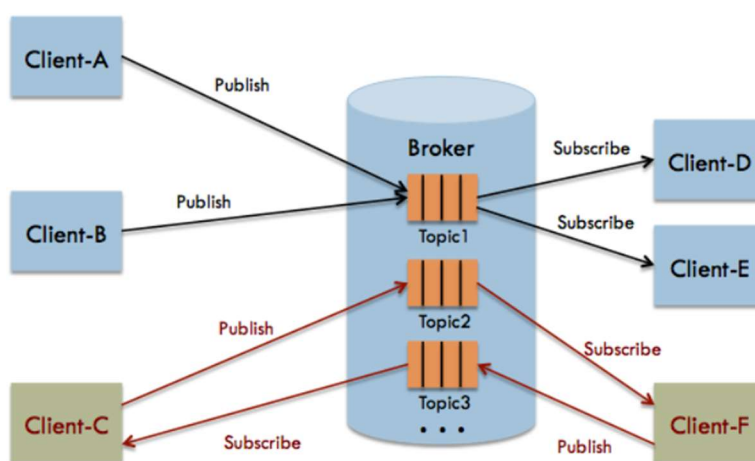

Figure 54 3-2-2 Subscribe/Distribute Architecture

MQTT gives you flexibility by specifying a *Quality of Service* (QoS) with each message. QoS is a parameter available on each publish call. It is one of three levels:

- QoS 0: At most once
- QoS 1: At least once
- QoS 2: Exactly once

Provides a Quality-of-Service data delivery: QoS can be selected based on the needs of the application.

MQTT Retained messages: The last published message (with retained flag set to true) is stored at the broker so that new subscribers can immediately obtain last known good value rather than wait for the next update from publisher.

REFERENCES: (The above information is from the following websites.)

<https://micropython-iot-hackathon.readthedocs.io/en/latest/mqtt.html>

<https://devopedia.org/mqtt>

MQTT Client Setting of the UA I/O:

Manu Path: 【MQTT Setting】 → 【Client Setting】 MQTT Setting → Client Setting (Appendix A).

The screenshot shows the 'Content Setting' interface with the following callouts:

1. Set an update frequency for the task data. Default: 1000 (Unit: ms)
2. The default value is 0, which means that any data changes will be published.
3. Enter a title of the disconnect notice.
4. Enter a disconnect notice.
5. Check "Enable", the message is sent in groups. Uncheck "Enable", the message is sent in singly.

Figure 55 3-2-2 MQTT Client Setting of the UA I/O

Enable of JSON Format: Descriptions for the **Enable (check "Enable") / Disable (uncheck "Enable")**

- **Enable:** Enter the Group setting screen, the Publish & Subscribe message is sent in a group. **Group setting (JSON Format)** the Publish & Subscribe: Suitable for obtaining all I/O values at one time, it can reduce network resources. It will pack all I/O point values into a JSON string, and then send the JSON string as a message or subscribe JSON string to get all I/O values back at one time. (Refer to Appendix B for the detailed JSON format)
- **Disable:** Enter the Singly setting screen, the Publish & Subscribe message is sent in singly (P to P). **Singly setting (Point-to-point)** the Publish & Subscribe: Suitable for I/O points that require high real-time performance, or devices that do not support generating or parsing JSON format.

The diagram illustrates the process of enabling or disabling JSON Format. It shows the 'Content Setting' screen with the 'JSON Format' checkbox checked (labeled 'Enable (Check)') and unchecked (labeled 'Disable (Uncheck)'). A green arrow points from the 'JSON Format' checkbox to the 'Publish & Subscribe' settings screen, which is divided into two views: 'Details' and 'Publish & Subscribe'.

Channel	Publish Topic	Publish QoS	Subscribe Topic	Subscribe QoS	Retain
DO0	/U-7526M/DO0/Publish	2	/U-7526M/DO0/Subscribe	2	<input type="checkbox"/>
DO1	/U-7526M/DO1/Publish	2	/U-7526M/DO1/Subscribe	2	<input type="checkbox"/>
DI0	/U-7526M/DI0/Publish	2		2	<input type="checkbox"/>
DI1	/U-7526M/DI1/Publish	2		2	<input type="checkbox"/>
Vout0	/U-7526M/Vout0/Publish	2	/U-7526M/Vout0/Subscribe	2	<input type="checkbox"/>
Vout1	/U-7526M/Vout1/Publish	2	/U-7526M/Vout1/Subscribe	2	<input type="checkbox"/>
Vin0	/U-7526M/Vin0/Publish	2		2	<input type="checkbox"/>
Vin1	/U-7526M/Vin1/Publish	2		2	<input type="checkbox"/>
Vin2	/U-7526M/Vin2/Publish	2		2	<input type="checkbox"/>
Vin3	/U-7526M/Vin3/Publish	2		2	<input type="checkbox"/>
Vin4	/U-7526M/Vin4/Publish	2		2	<input type="checkbox"/>
Vin5	/U-7526M/Vin5/Publish	2		2	<input type="checkbox"/>

Figure 56 3-2-2 JSON Format Enable/Disable Setting

The setting parameters for Both enable or disable the JSON Format:

Table 29 3-2-2 MQTT Setting > Client Setting - Publish & Subscribe

MQTT Setting > Client Setting - Publish & Subscribe	
Publish Topic	The topic of sending data / publishing message.
Publish QoS	The publish Qos (Quality of Service) levels. Default: 2 0: Delivering a message at most once. 1: Delivering a message at least once. 2: Delivering a message at exactly once.
Subscribe Topic	The topic of receiving data / subscribing message. It can copy the Publish Topic of linked device.
Subscribe QoS	The subscribe Qos (Quality of Service) levels. Default: 2 0: Delivering a message at most once. 1: Delivering a message at least once. 2: Delivering a message at exactly once.
Retain	Set up if the Broker retains the message.
Save	Click to save the setting of this page.

When **Enable JSON format**, it will pack all I/O point values into a JSON string, and then send the JSON string as a message or subscribe JSON string to get all I/O values back at one time. (Refer to [Appendix B](#))

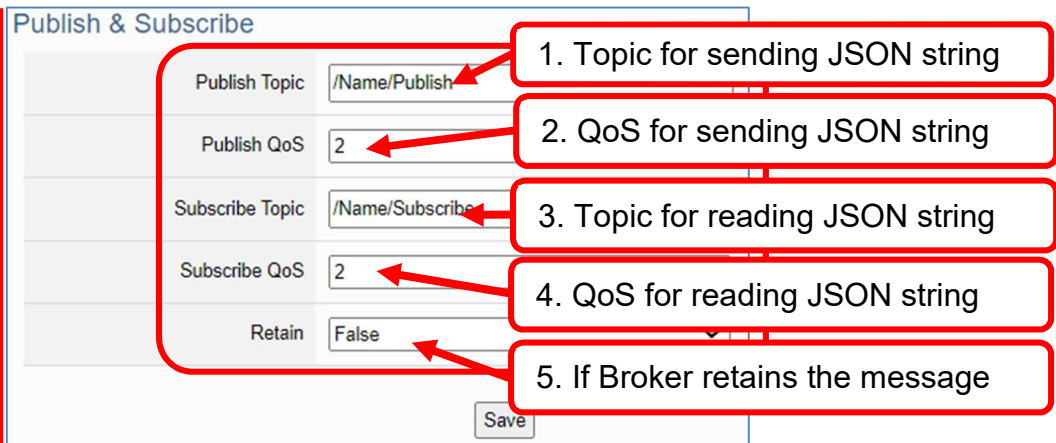

Figure 57 3-2-2 MQTT Setting > Client Setting - Publish & Subscribe(1)

When **Disable JSON format**, it will publish or subscribe the message in singly (Point-to-point). User needs to set each I/O point.

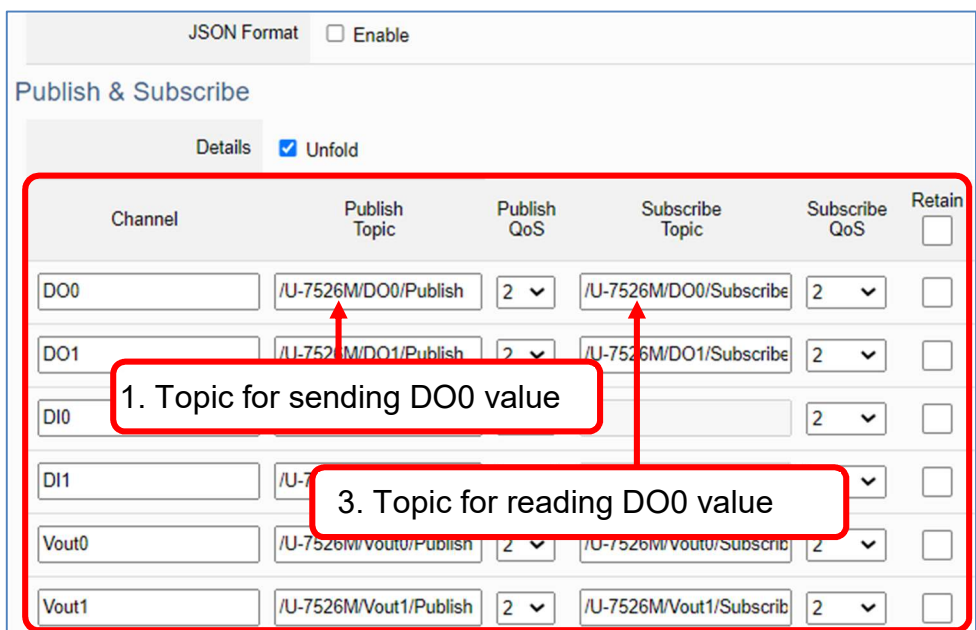

Figure 58 3-2-2 MQTT Setting > Client Setting - Publish & Subscribe(2)

● Group Setting example: Check “Enable” of “JSON Format”

Here is an example of the lighting control in a factory. Use the I/O points of the U-7555M module to connect the light switches of Room 1 to 7 in the factory Building-A to monitor/control the on/off of the room lights. We want to use the **Group Setting**, so **check "Enable"** of the **"JSON Format"**. The following is a parameter example for the settings of **[MQTT Setting] > [Client Setting]**.

Content Setting

Scan Rate(ms)	1000	1. Set the update frequency for the task data (1000 ms)
Dead Band	0	2. Do not set the Dead Band, so keep 0.
Will Topic	/A/1F/U-7555M	3. Set disconnect Topic for 1F of Building-A (U-7555M)
Will	Disconnection	4. Set Will message: Disconnection
JSON Format	<input checked="" type="checkbox"/> Enable	5. Check to Enable JSON format to enter the Pub/Sub screen page for Group setting.

Figure 59 3-2-2 Group Setting example: Check “Enable” of “JSON Format”(1)

The Pub & Sub setting page when enable the JSON Format: Sending/Reading the JSON string

Publish & Subscribe

Publish Topic	/A/1F/U-7555M/Publish	1. Topic of the publish JSON string: /Build-A/1F/U-7555M/all I/O sending data
Publish QoS	2	2. Set QoS to level 2 for publish. 2: exactly once
Subscribe Topic	/A/1F/U-7555M/Subscribe	3. Topic of the subscribe JSON string: /Build-A/1F/U-7555M/all I/O reading data
Subscribe QoS	2	4. Set QoS to level 2 for subscribe. 2: exactly once
Retain	True	5. Check to set the Broker retain the message
Save		6. Save all settings of this page.

Note:

When setting the Pub/Sub of MQTT Client, please also set the Nickname of I/O channel, which includes MQTT Nickname and OPC UA Description.

MQTT Client setting should cooperate with MQTT Nickname of the I/O channels for the accuracy/readability of MQTT communication settings.

Menu: **【 Module Setting 】 > 【 I/O Setting 】**
As shown on the right.

Channel	MQTT Alias	OPC UA Description	Power-on Value
DO0	A-1F-Entrance-door	A-1F-Entrance-door_AA	<input type="checkbox"/>
DO1	A-1F-1R-light-1	A-1F-1R-light-1_Aa12	<input type="checkbox"/>
DO2	A-1F-2R-light-2	A-1F-2R-light-2_Aa12	<input type="checkbox"/>
DO3	A-1F-3R-light-3	A-1F-3R-light-3_Aa12	<input type="checkbox"/>
DO4	A-1F-4R-light-4	A-1F-4R-light-4_Aa12	<input type="checkbox"/>
DO5	A-1F-5R-light-5	A-1F-5R-light-5_Aa12	<input type="checkbox"/>
DO6	A-1F-6R-light-6	A-1F-6R-light-6_Aa12	<input type="checkbox"/>
DO7	A-1F-7R-light-7	A-1F-7R-light-7_Aa12	<input type="checkbox"/>

Save

Figure 60 3-2-2 Group Setting example: Check “Enable” of “JSON Format”(2)

● Singly Setting example: Uncheck “Enable” of “JSON Format”

Here is an example of the lighting control in a factory. Use the I/O points of the U-7555M module to connect the light switches of Room 1 to 7 in the factory Building-A to monitor/control the on/off of the room lights. We want to use the **Point-to-Point Setting**, so **uncheck** "Enable" of the "JSON Format". The following is a parameter example for the settings of [MQTT Setting] > [Client Setting].

Content Setting

Scan Rate(ms)	1000	1. Set the update frequency for the task data (1000 ms)
Dead Band	0	2. Do not set the Dead Band, so keep 0.
Will Topic	/A/1F/U-7555M	3. Set disconnect Topic for 1F of Building-A (U-7555M)
Will	Disconnection	4. Set Will message: Disconnection
JSON Format	<input type="checkbox"/> Enable	5. Uncheck to Enable JSON format to enter the Pub/Sub screen page for Group setting.

Figure 61 3-2-2 Singly Setting example: Uncheck “Enable” of “JSON Format”(1)

Publish & Subscribe

IO# Ch.	Channel	Publish Topic	Publish QoS	Subscribe Topic	Subscribe QoS	Retain
DO0		/A/1F/Entrance-door/Pub	2	/A/1F/Entrance-door/Sut	2	<input checked="" type="checkbox"/>
DO1		/A/1F/light-1/Publish	2	/A/1F/light-1/Subscribe	2	<input checked="" type="checkbox"/>
DO2		/A/1F/light-2/Publish	2	/A/1F/light-2/Subscribe	2	<input checked="" type="checkbox"/>
DO3		/A/1F/light-3/Publish	2	/A/1F/light-3/Subscribe	2	<input checked="" type="checkbox"/>
DO4		/A/1F/light-4/Publish	2	/A/1F/light-4/Subscribe	2	<input checked="" type="checkbox"/>
DO5		/A/1F/light-5/Publish	2	/A/1F/light-5/Subscribe	2	<input checked="" type="checkbox"/>
DO6		/A/1F/light-6/Publish	2	/A/1F/light-6/Subscribe	2	<input checked="" type="checkbox"/>
DO7		/A/1F/light-7/Publish	2	/A/1F/light-7/Subscribe	2	<input checked="" type="checkbox"/>
IN0		/U-7555M/IN0/Publish	2		2	<input checked="" type="checkbox"/>
IN1		/U-7555M/IN1/Publish	2		2	<input checked="" type="checkbox"/>
IN2		/U-7555M/IN2/Publish	2		2	<input checked="" type="checkbox"/>
IN3		/U-7555M/IN3/Publish	2		2	<input checked="" type="checkbox"/>
IN4		/U-7555M/IN4/Publish	2		2	<input checked="" type="checkbox"/>
IN5		/U-7555M/IN5/Publish	2		2	<input checked="" type="checkbox"/>
IN6		/U-7555M/IN6/Publish	2		2	<input checked="" type="checkbox"/>
IN7		/U-7555M/IN7/Publish	2		2	<input checked="" type="checkbox"/>

Save

Uncheck the JSON Format to do the Point-to-Point singly setting (as the left figure): User needs to set up each Topic/QoS of Publish/Subscribe for each I/O channel.

1. Set the Publish Topic of DO0 and set each IO#. Topic means: /Building-A/1F/light# of U-7555M/Topic
2. The level of sending Topic for each IO#. level 2: Exactly once
3. Set the Subscribe Topic of DO0 and set each IO#. Topic means: /Building-A/1F/light# of U-7555M/Topic
4. The level of reading Topic for each IO#. level 2: Exactly once
5. Check to set the Broker retain the message

6. Save all settings.

Figure 62 3-2-2 Singly Setting example: Uncheck “Enable” of “JSON Format”(2)

3.2.3 Secure Encrypted Connection: MQTT Certificate

When using the MQTT connection, in addition to the account login for security, users can also enable the SSL/TLS login to use the MQTT Certificate protection of the secure encryption. This section describes how to download/upload the certificates. If you do not want to enable the certificate login, please skip.

The settings of MQTT certificate connection need to enable the SSL/TLS secure encryption. And the UA I/O needs to get the certificate of the connecting device first. And then upload the certificates to UA I/O. There are three types of certificates: Trusted Certificate, Certificate, and Private Key.

Please upload the files to the UA I/O module according to the type of certificates:

To perform the One-way authentication, you need to upload the Trusted Certificate.

To perform the Two-way authentication, you need to upload the Trusted Certificate first, and then upload the Certificate and Private Key.

Note:

1. One-way authentication: The Client verifies the validity of Broker credentials; need to upload the Trusted Certificate.
2. Two-way authentication: The Client and Broker verify the validity of the certificate with each other; need to upload the Trusted Certificate first, and then upload the Certificate and Private Key.
3. Trusted Certificate: File format must be PEM. Extension name must be "pem", "cer", or "crt".
4. Certificate: File format must be PEM. Extension name must be "pem", "cer", or "crt".
5. Private Key: File format must be PEM. Extension name must be "key".

Manu Path: 【MQTT Setting】 → 【Client Setting】 MQTT Setting → Client Setting (Appendix A).

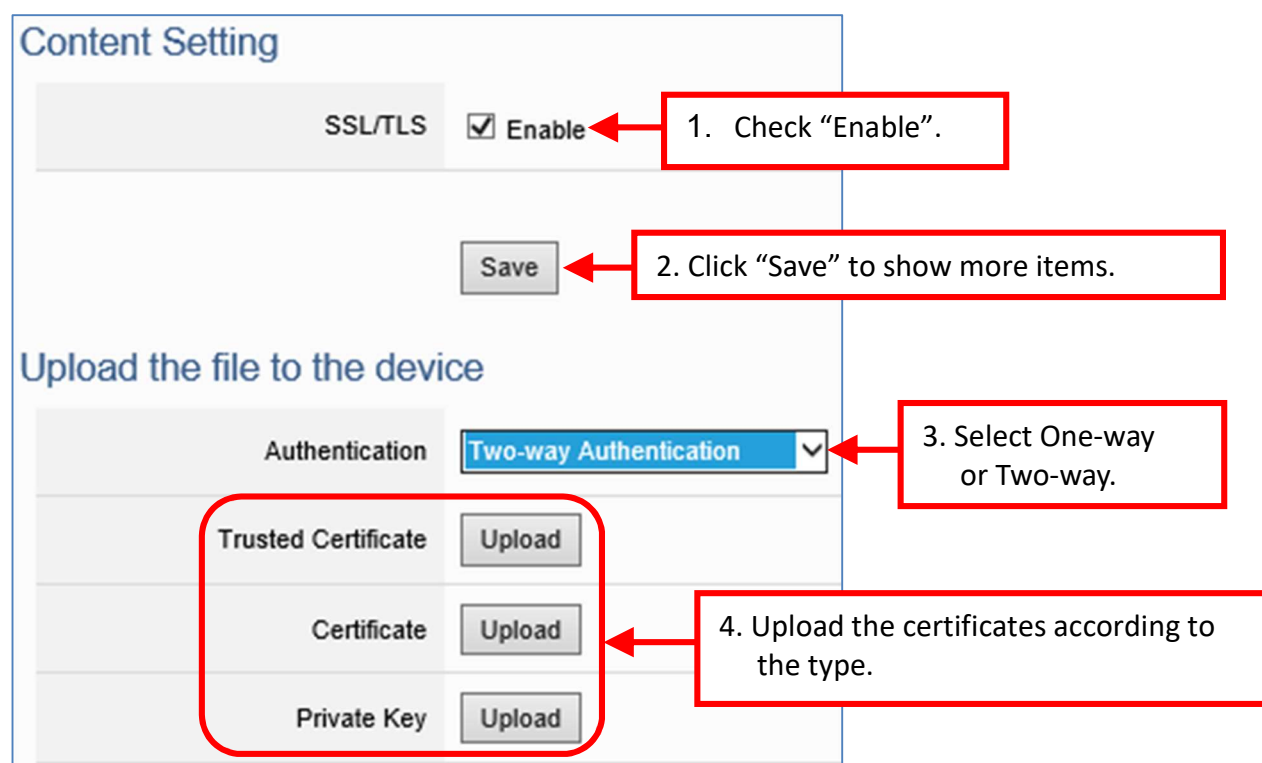

Figure 63 3-2-3 Secure Encrypted Connection: MQTT Certificate

3.3 RESTful API: Read and Write I/O and Virtual Point

This section describes RESTful API functions and usage. UA I/O supports RESTful API functions. Users can remotely read and write the I/O points (include the virtual point) of UA I/O modules through HTTP.

What is Restful API?

REST (Representational state transfer) is a software architectural style that was created to guide the design and development of the architecture for the World Wide Web. REST is a widely accepted set of guidelines for creating stateless, reliable web APIs. A web API that obeys the REST constraints is informally described as **RESTful**. RESTful web APIs are typically loosely based on HTTP methods to access resources via URL-encoded parameters and transmit data.

Use RESTful with UA I/O

Reading and writing the virtual tag points are the same as that of physical I/O points. Examples:

[Example 1.]

IP/AllVariableName : Define 10 virtual points (all types are AO), and the names all start with VirtualTag (red box in the figure below).

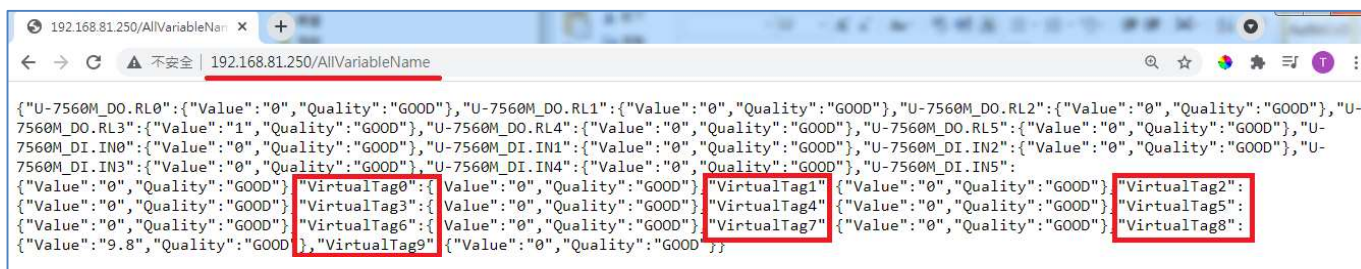

Figure 64 3-3 Restful API [Example 1-1]

Or as following:

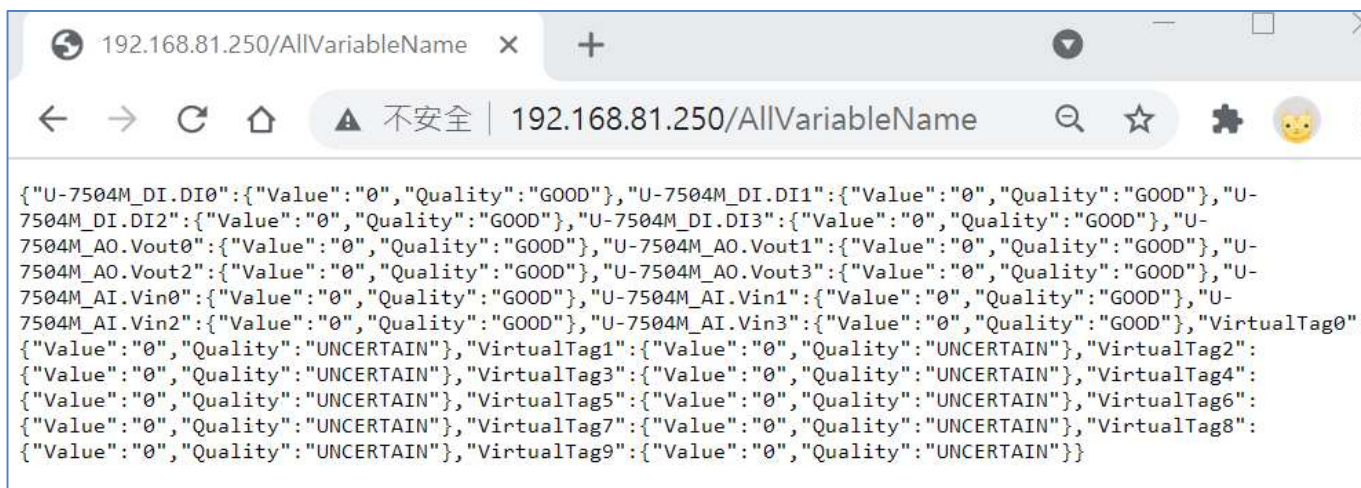

Figure 65 3-3 Restful API [Example 1-2]

[Example 2.]

IP/VariableInformation?VirtualTag0 : RESTful **Read** the value of VirtualTag0

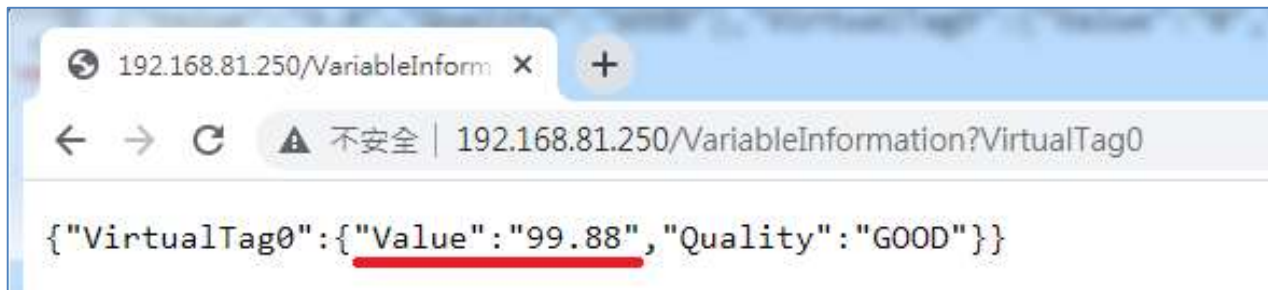

Figure 66 3-3 Restful API [Example 2-1]

Or as following:

IP/VariableInformation?U-7504M_DI.DI0 : RESTful **Read** the DI.DI0 value of U-7504M.

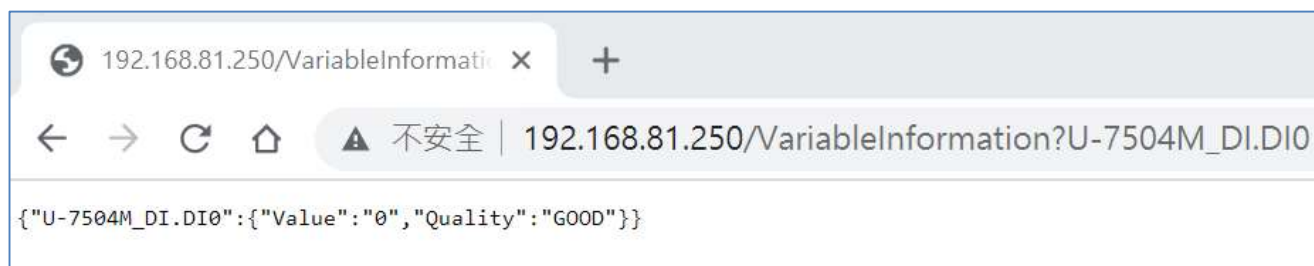

Figure 67 3-3 Restful API [Example 2-2]

[Example 3.]

IP/VariableInformation : RESTful **write** the value of VirtualTag0

This example uses the Firefox as the RESTful client.

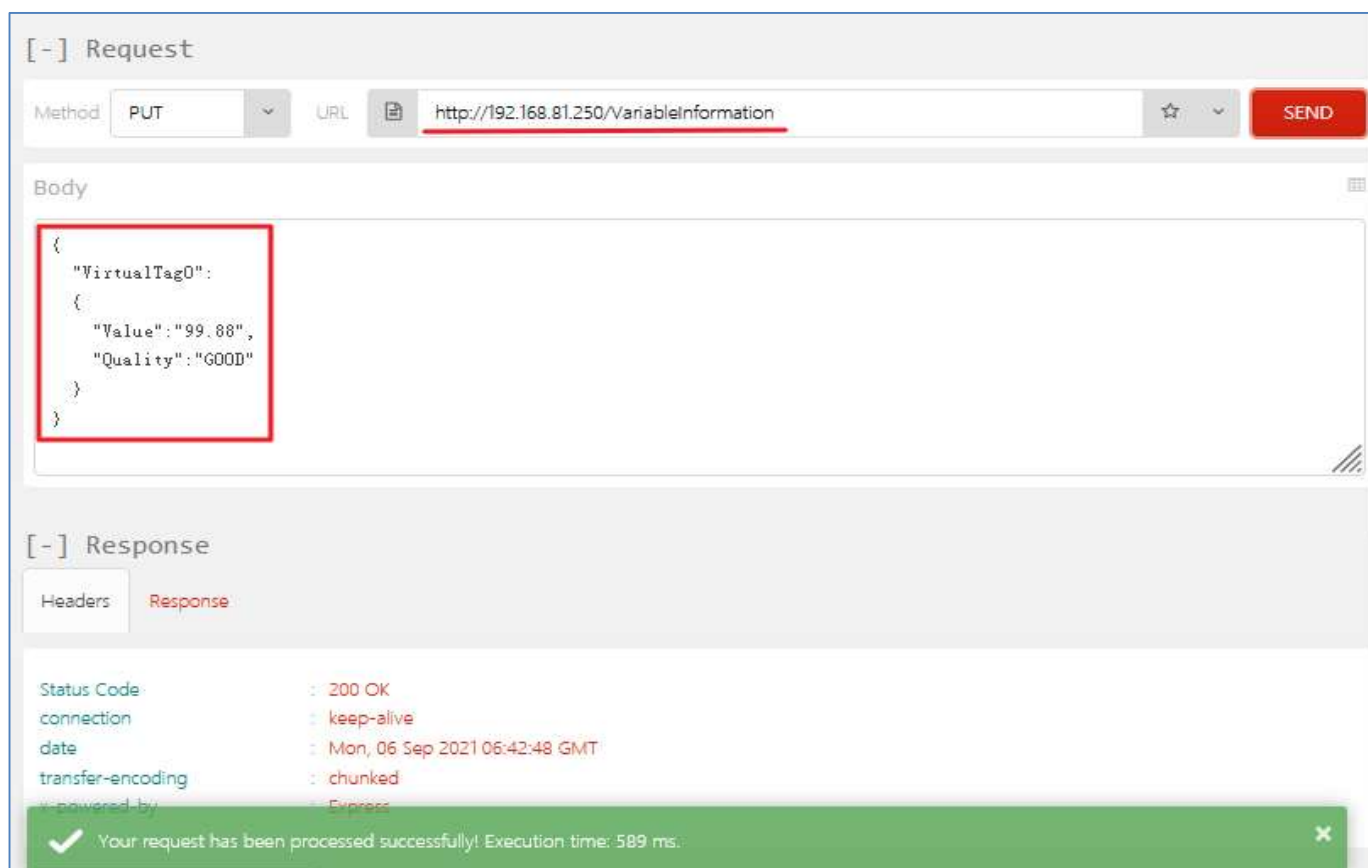

Figure 68 3-3 Restful API [Example 3]

RESTful Description

[Resource Definition]

Table 30 3-3 RESTful [Resource Definition]

HTTP Method	Path	Description	Remarks
GET	/AllVariableName	Read all variable data.	Link to Example G1.1
	/VariableInformation?var0,var1, var2...	Read the data of var0, var1, var2... in all variables, data are separated by commas.	Link to Example G1.2
PUT	/VariableInformation	writes the variable data being used.	Link to Example P1.1

[JSON Description]

Table 31 3-3 RESTful [JSON Description]

JSON Content	Item	Description
<pre>{ "Var1": { "Quality": "Good", "Value": "24.5" }, "Var2": { "Quality": "Good", "Value": "24.5" } }</pre>	Quality	The communication quality of the variable. Return Item: Good, Uncertain, Bad.
	Value	Return the value of the variable.

[GET Examples]

Table 32 3-3 RESTful [GET Examples]

Resource Definition	Actual Application Corresponding to the Resource Definition
GET /AllVariableName	GET /AllVariableName
Description Back to G1.1	
<p>GET : Read</p> <p>/AllVariableName : All variables</p> <p>For Example :</p> <p>GET /AllVariableName : Read all variable data, and the return value is in JSON format.</p>	
Resource Definition	Actual Application Corresponding to the Resource Definition
GET /VariableInformation?var0, var1, var2...	GET /VariableInformation?U-7560M_DO.RL0,U-7560M_DO.RL1
Description Back to G1.2	
<p>GET : Read</p> <p>/VariableInformation : Variable Information.</p> <p>? : Used to separate the API and the parameters.</p> <p>U-7560M_DO.RL0 : The variable name of the module.</p> <p>U-7560M_DO.RL1 : The variable name of the module.</p> <p>Use "commas" to separate variables.</p> <p>For Example :</p> <p>GET /VariableInformation?U-7560M_DO.RL0, U-7560M_DO.RL1</p> <p>The data of variables such as U-7560M_DO.RL0, U-7560M_DO.RL1. The return value is in JSON format.</p>	

[PUT Example]

Table 33 3-3 RESTful [PUT Examples]

Resource Definition	Actual Application Corresponding to the Resource Definition
PUT /VariableInformation	PUT /var/use [RAW Body] <pre> { "Var1": { "Quality": "Good", "Value": "24.5" }, "Var2": { "Quality": "Good", "Value": "24.5" } } </pre>
Description Back to P1.1	
<p>PUT : Write</p> <p>/VariableInformation : Variable Information.</p> <p>[RAW Body] : The JSON format to be written.</p> <p>PUT /VariableInformation : Compare from [RAW Body], check whether the variable name exists on the server side, modify it if it exists, and skip it if it doesn't. The return value is a string.</p>	

Use RESTful API HTTPS with UA I/O

Before using RESTful API HTTPS, users need to check whether "Https Web Server" has imported the certificate.

If the certificate has not been imported, please open the web interface and switch to the following menu location to upload the certificate.

Manu Path:

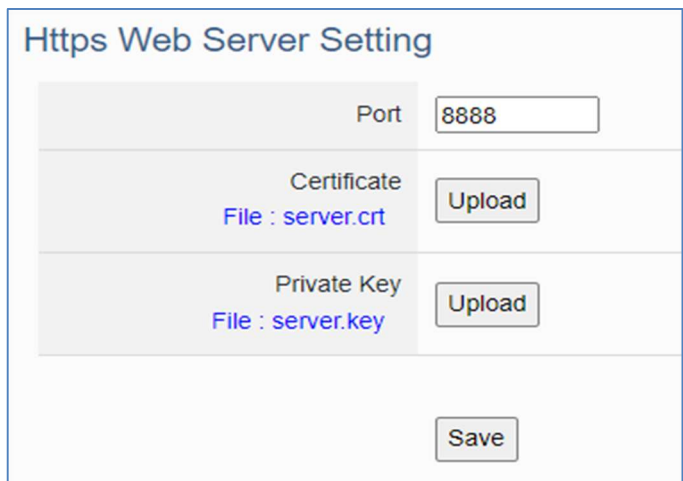
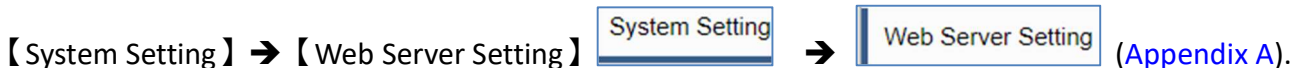

Figure 69 3-3 RESTful API HTTPS Web Server Setting

After uploading the certificate, users can read and write I/O according to the RESTful API example in the previous section.

Apply on the Website Address Bar:

https://IP:Port/Resource Definition

IP : Device IP.

Port : Https Web Server Port; Default is 8888 for UA I/O.

[Example] : **https://192.168.81.250:8888/AllVariableName**



Figure 70 3-3 https://IP:Port/Resource Definition

3.4 Common settings table for easy integration

This section explains how UA I/O can obtain the necessary settings for software integration, allowing users to integrate the site more quickly. UA-I/O provides a common settings table that includes the settings of OPC UA, MQTT, and HTTP (HTTPS) protocols. These settings are compiled into a file so that users can find the required settings quickly and easily.

The following is the UA-I/O with ICP DAS product AVEVA Edge as an example of how to use the common setup table.

Setting Steps:

[Step 1]

Menu Path:

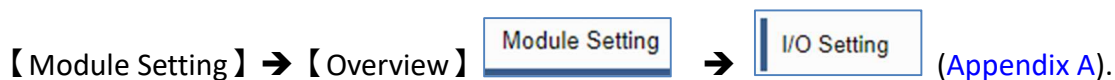

Set the Nickname: Enter a name that is easily identifiable.

Analog Input			
Channel	Nickname	OPC UA Description	Input Type
Vin0	二樓_A房_電熱水器		-10 ~ 10 V ▾
Vin1	2階_B室_電氣溫水器		-10 ~ 10 V ▾
Vin2	2층_C룸_전기온수기		-10 ~ 10 V ▾
Vin3	Электрический водонагрев		-10 ~ 10 V ▾
Vin4	ชั้น 2 ห้อง E เครื่องทำน้ำอุ่น		-10 ~ 10 V ▾
Vin5	Salle F_Chauffe-eau électrique		-10 ~ 10 V ▾

Figure 71 3-4 Common settings(1)

[Step 2]

Menu Path:

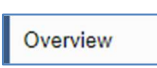
【Module Setting】 → 【Overview】  →  (Appendix A).

Click the Download button and get CommonSettings.csv



Figure 72 3-4 Common settings(2)

[Step 3]

Find the settings for the software by "Nickname" and copy and paste them into the software settings to complete the communication integration.

Below is an example of AVEVA Edge.

20	EnablePowerOnValue		ns=2;s=U-7526M.EnablePowerOnValue
21	Vin0	二樓_A房_電熱水器	ns=2;s=U-7526M.Vin0
22	Vin1	2階_B室_電氣溫水器	ns=2;s=U-7526M.Vin1
23	Vin2	2층_C룸_전기온수기	ns=2;s=U-7526M.Vin2
24	Vin3	Электрический водонагреватель	ns=2;s=U-7526M.Vin3
25	Vin4	ชั้น 2 ห้อง E เครื่องทำน้ำอุ่น	ns=2;s=U-7526M.Vin4
26	Vin5	Salle F_Chauffe-eau électrique	ns=2;s=U-7526M.Vin5
27	Vin0_Type		ns=2;s=U-7526M.Vin0_Type
28	Vin1_Type		ns=2;s=U-7526M.Vin1_Type
29	Vin2_Type		ns=2;s=U-7526M.Vin2_Type
30	Vin3_Type		ns=2;s=U-7526M.Vin3_Type

Figure 73 3-4 Common settings(3)

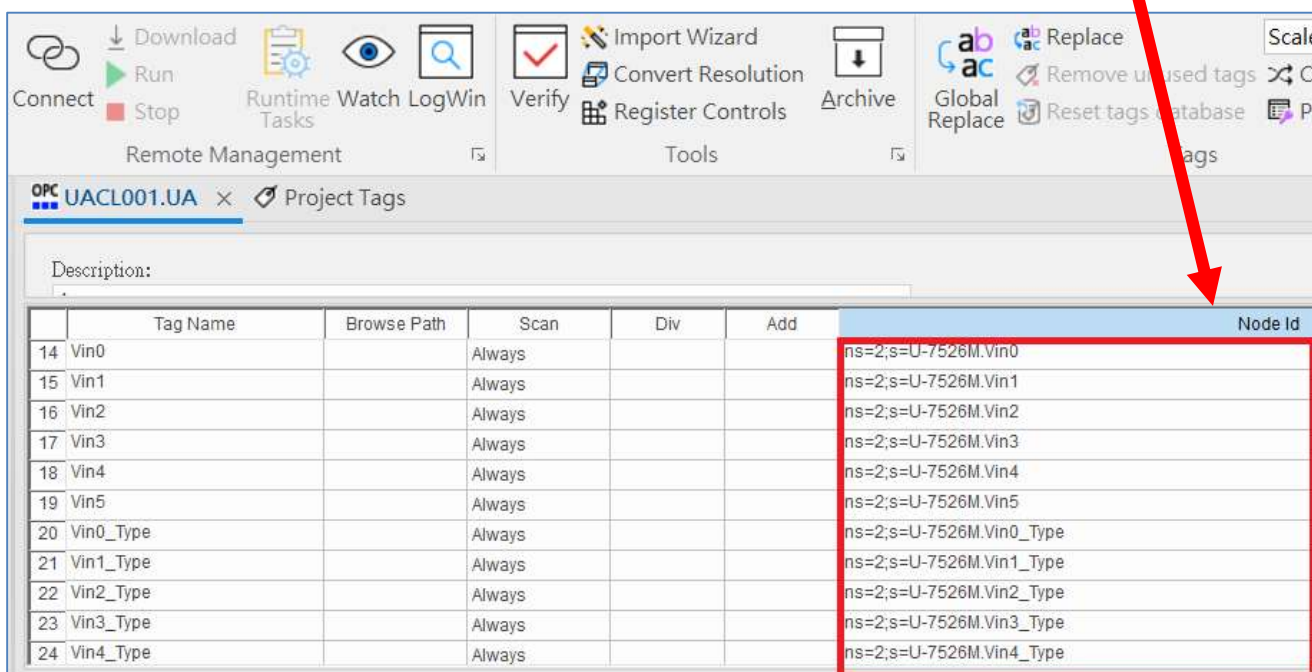

Figure 74 3-4 Common settings(4)

3.5 IoTstar Connection Example

This section introduces the IoTstar connection settings. Please go to the IoTstar setting menu.



(Appendix A)

Please go to the following link to apply for a free trial account

<https://www.icpdas.com/en/product/guide+IIoT+Software+IoTstar#1080>

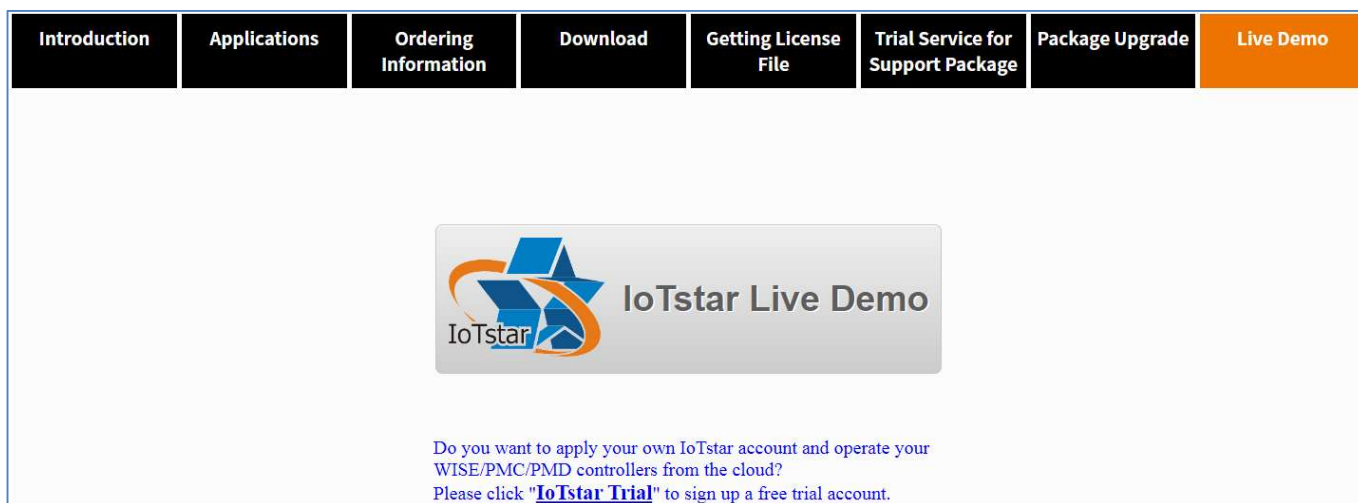

Figure 75 3-5 IoTstarLive Demo webpage

Enter the following information:

Server IP: iotstardemo.icpdas.com

Username: **The account name of the free trial account**

Password: **Password for a free trial account**

The other items are default values and click Save. The screen is as follows.

Connection Setting

Server IP	<input type="text" value="iotstardemo.icpdas.com"/>
Server Port	<input type="text" value="1234"/>
Username	<input type="text" value="iotstar_rd9"/>
Password	<input type="password" value="*****"/>
Nickname	<input type="text" value="U-7500M"/>
FTP Port	<input type="text" value="1231"/>
History Data Intervals (Seconds)	<input type="text" value="60"/>
KEY (8 characters)	<input type="password" value="*****"/>
IV (8 characters)	<input type="password" value="*****"/>
Real-Time I/O Data	<input type="checkbox"/> Enable
Historical I/O Data	<input type="checkbox"/> Enable

Success

Figure 76 3-5 Connection Setting

After saving successfully, the connection will be completed.

4. Main Menu: Parameter Descriptions

This chapter introduces the menu functions of the UA I/O web UI and is more focused on the function parameters of the menu. Each section introduces one main menu and its sub-menu functions. The function location is shown in a brief text and diagram of **【Menu Path】**, for Menu Path introductions please refer to [Appendix A](#).

4.1 Main Menu - System Setting

System Setting is the first item of the Main Menu. This item is about the settings related to the hardware and operating system.

4.1.1 Overview

Function: Display the current information on the hardware and operating system.

Support Module: All UA I/O modules support this function.

Manu Path: **【System Setting】** → **【Overview】** System Setting → Overview (Refer to [Appendix A](#)).

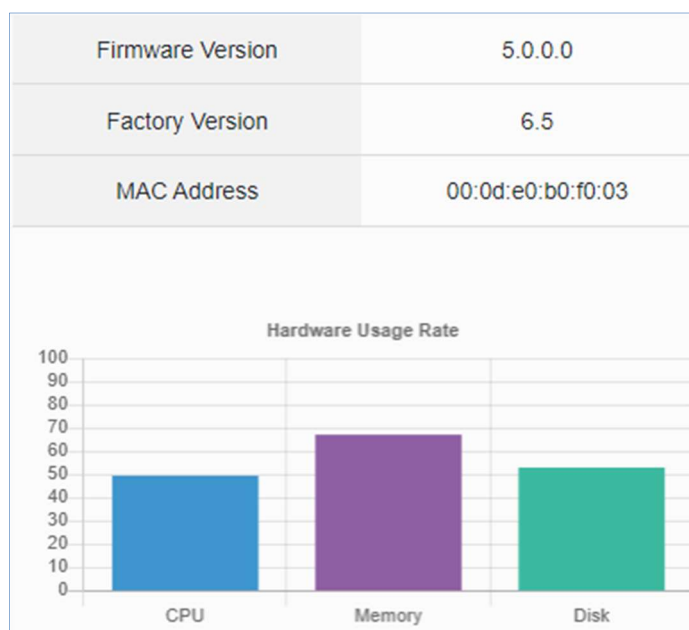

Figure 77 4-1-1 System Setting

Table 34 4-1-1 System Setting-Overview

System Setting > Overview	
Firmware Version	Display the firmware version of the UA I/O module.
Factory Version	Display the factory version (OS & UI) of the UA I/O module.
MAC Address	The LAN MAC address of this UA I/O.
CPU	Display the current CPU usage of the module. Do not use to achieve 95% or more.
Memory	Display the current memory usage of the module. Do not use to achieve 95% or more.
Disk	Display the current disk usage of the module. Do not use to achieve 95% or more.

4.1.2 Network Setting

Function: Display and set up the network settings of the UA I/O.

Support Module: All UA I/O modules support this function.

Manu Path: 【System Setting】 → 【Network Setting】 System Setting → Network Setting (Appendix A).

Network Setting (LAN)

Network Setting (LAN)

Connection Mode	<input checked="" type="radio"/> Specify an IP address. <input type="radio"/> Obtain an IP address automatically.(DHCP)
IP Address	<input style="width: 40px;" type="text" value="192"/> · <input style="width: 40px;" type="text" value="168"/> · <input style="width: 40px;" type="text" value="81"/> · <input style="width: 40px;" type="text" value="252"/>
Mask	<input style="width: 40px;" type="text" value="255"/> · <input style="width: 40px;" type="text" value="255"/> · <input style="width: 40px;" type="text" value="0"/> · <input style="width: 40px;" type="text" value="0"/>
Gateway	<input style="width: 40px;" type="text" value="192"/> · <input style="width: 40px;" type="text" value="168"/> · <input style="width: 40px;" type="text" value="1"/> · <input style="width: 40px;" type="text" value="1"/>
MAC Address	00:00:00:00:81:52

Figure 78 4-1-2 Network Setting (LAN)

Table 35 4-1-2 Network Setting (LAN)

System Setting > Network Setting - Network Setting (LAN)	
Connection Mode	Specify an IP address: Users input the values in the fields of IP, Mask, and Gateway according to the customer's network. Detail information for the factory default value of the UA controller network refers to the. Sec. 4.1.7 Obtain an IP address automatically (DHCP): It's the Dynamic Host Configuration Protocol mode. The system assigns the IP, Mask, and Gateway automatically.
IP Address	The LAN IP address of this UA I/O. Factory Default: 192.168.255.1
Mask	The LAN mask address of this UA I/O. Factory Default: 255.255.0.0
Gateway	The LAN gateway address of this UA I/O. Factory Default: 192.168.1.1
MAC Address	The LAN MAC address of this UA I/O.
Save	Click to save the settings of the LAN item.

Hostname Setting

The screenshot shows a web-based configuration interface for setting the hostname. At the top, the title 'Hostname Setting' is displayed in blue. Below the title, there is a light gray header bar containing the label 'Hostname'. To the right of this label is a text input field with a white background and a thin border, containing the alphanumeric string 'U7560M000de0b0f003'. Below the input field, centered, is a rectangular button with a light gray background and a thin border, labeled 'Save'.

Figure 79 4-1-2 Hostname Setting

Table 36 4-1-2 Hostname Setting

System Setting > Network Setting - Hostname Setting	
Hostname	The host name of this UA I/O. Default: system value. Users can give a new name, but cannot be null, Chinese characters, or special symbols.
Save	Click to save the settings of this item.

4.1.3 Time Setting

Function: Display and set up the date and time of the UA I/O.

Support Module: All UA I/O modules support this function.

Manu Path: 【System Setting】 → 【Time Setting】 System Setting → Time Setting (Appendix A).

Date and Time Display

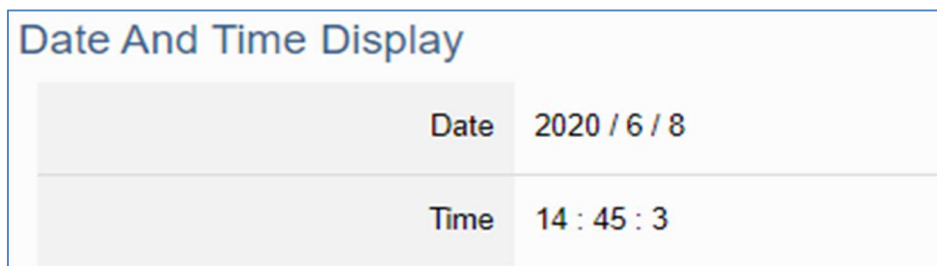

Figure 80 4-1-3 Date and Time Display

Table 37 4-1-3 Date and Time Display

System Setting > Time Setting - Date And Time Display	
Date	Display the date of the UA I/O module, including year, month, and day.
Time	Display the current time of the UA I/O module, including hour, minute, and second.

When the device time is one day different from the local computer time, a warning message "Please check the time" will be displayed, as shown below.

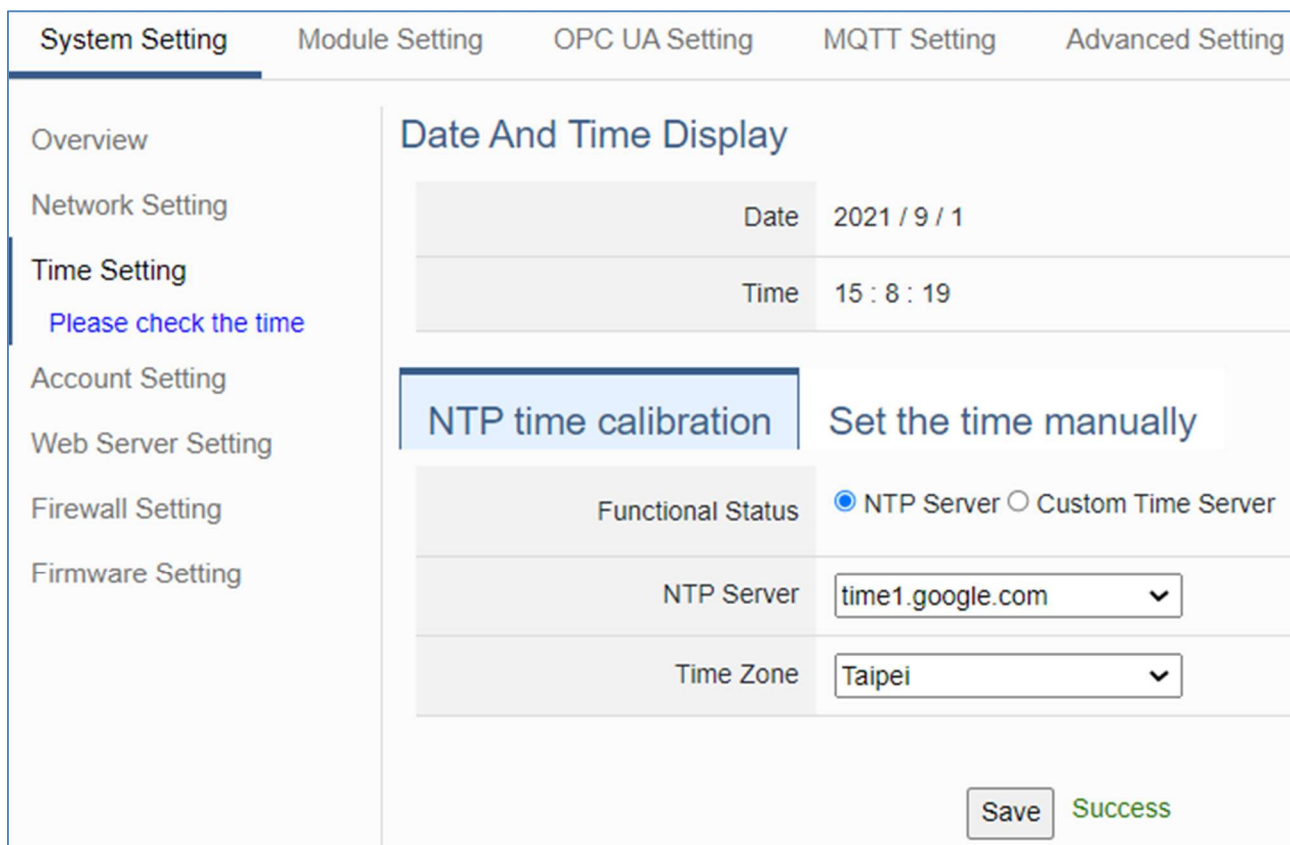

Figure 81 4-1-3 Time Setting-Please check the time

NTP time calibration

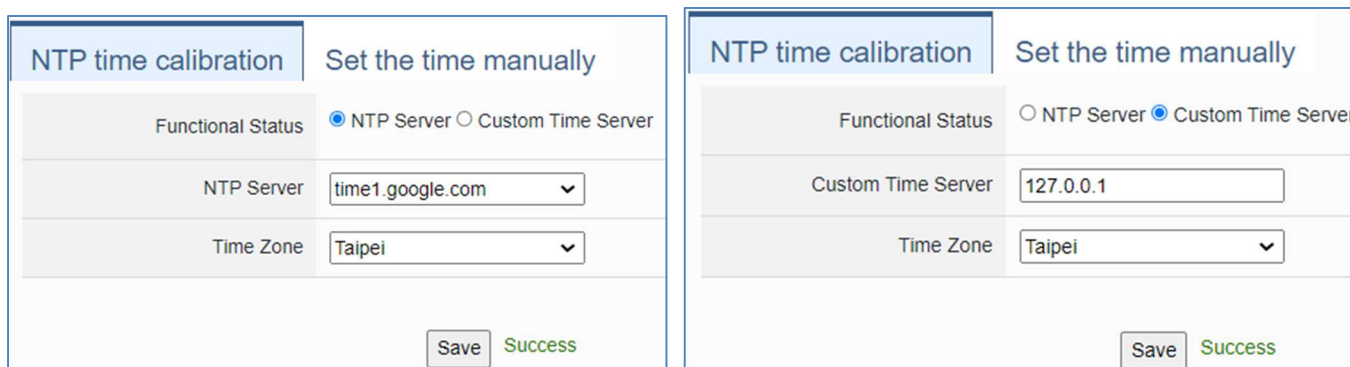

Figure 82 4-1-3 NTP time calibration

Table 38 4-1-3 NTP time calibration

System Setting > Time Setting - NTP time calibration	
Functional Status	NTP Server: Click to display the setting columns for NTP Server. Custom Time Server: Click to display the setting columns for Custom Time Server.
NTP Server	Select the common time server provided by the system.
Custom Time Server	Enter the IP address of the time server by custom.
Time Zone	Select the time zone of your location.
Save	Click to save the settings of this item and update the data of “Time Setting” to the “Date And Time Display” on the top of this page.

Set the time manually

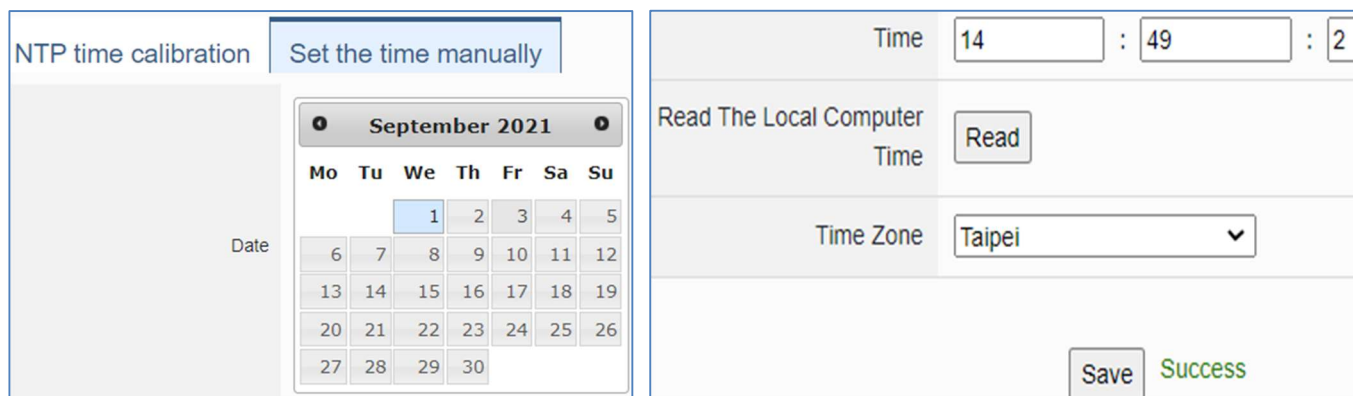

Figure 83 4-1-3 Set the time manually

Table 39 4-1-3 Set the time manually

System Setting > Time Setting - Set The Time Manually	
Date	Set the system date of the UA I/O manually. Directly enter the new year/month/day, and then click “Save”.
Time	Set the system time of the UA I/O manually. Directly enter the new hour: minute: and second, and then click “Save”.
Read The Local Computer Time	Click [Read] can copy the current time of the using computer to the “Time Setting” of this item.
Time Zone	Select the time zone of your location.
Save	Click to save the settings of this item and update the data of “Time Setting” to the “Date And Time Display” on the top of this page.

4.1.4 Account Setting

Function: Display and set up the login username and password of the UA I/O Web UI.

Support Module: All UA I/O modules support this function.

Manu Path: 【System Setting】 → 【Account Setting】 System Setting → Account Setting (Appendix A).

There are two modes of account setting: **Administrator Setting** and **User Setting**, only one administrator or user can log in at any one time. The administrator login provides customers with the most complete device information and setting items.

The user login only allows customers to read device I/O point information and control items.

Administrator Setting

Account Setting:

Figure 84 4-1-4 Account Setting

Table 40 4-1-4 Account Setting

System Setting > Account Setting	
Username	The login username for the UA Web UI. Factory default: root. Cannot be null. After the first login in using the factory default settings, change the default username/password first, or the user cannot use any other function (designed for data security) except the [Overview] and [Account Setting] (Mouse showing hand shape).
Password	The login password for the UA Web UI. Factory default: root. Cannot be null. After the first login in using the factory default settings, change the default username/password first, or the user cannot use any other function (designed for data security) except the [Overview] and [Account Setting] (Mouse showing hand shape). Password setting rules: <div style="border: 1px solid #ccc; padding: 5px; margin-top: 5px;"> <ul style="list-style-type: none"> 1. Must not be the same as the account. 2. The length must be greater than 6 characters. 3. With English uppercase. 4. With English lowercase. 5. With numbers. </div>
Confirm Password	Retype the password for the operation conform when setting the new account information.
Save	Click to save the settings of this page.

Login Error Notification:

The screenshot shows a configuration window titled "Login Error Notification". It contains several input fields and a button:

- Number Of Login Errors:** A text box containing the value "3".
- Server Name:** A text box with a blurred value.
- Server Port:** A text box containing the value "587".
- Mailbox:** A text box with a blurred value.
- Mailbox Password:** A text box with masked characters "*****".
- Incoming Mailbox:** A text box with a blurred value.
- Subject:** A text box containing "ICPDAS U-7500M Notification".
- Content:** A text area containing "This device has an abnormal web login." with a scroll bar on the right.
- Sending Test:** A button labeled "Test".

Figure 85 4-1-4 Login Error Notiifcation

Table 41 4-1-4 Login Error Notification

System Setting > Account Setting - Login Error Notification	
Number Of Login Errors	Default: 3 The number of times the wrong account or password is allowed. Example: Set the value 3. If the input is wrong 3 times, the system will send a notification.
Server Name	Mail server URLs provided by MIS, or URLs of major well-known mail servers.
Server Port	Default: 587 The mail server Port is provided by MIS, or the ports of major famous mail servers.
Mailbox	Set up an available mailbox for sending emails to notify customers.
Mailbox Password	Enter the password for the mailbox.
Incoming Mailbox	The mailbox to receive messages.
Subject	Default: ICP DAS U-7500M Notification. The subject of the sanding letter.
Content	Default: This device has an abnormal web login. The content of the sanding letter.
Sending Test	Click the test button. After success, the settings are available. At the same time, the set value is also stored in the device.

User Setting

Account Setting:

Figure 86 4-1-4 User Setting

Table 42 System Setting-Account Setting

System Setting > Account Setting			
Username	The login username for the UA Web UI. Factory default: root. Cannot be null. After the first login in using the factory default settings, change the default username/password first, or the user cannot use any other function (designed for data security) except the [Overview] and [Account Setting] (Mouse showing hand shape).		
Password	The login password for the UA Web UI. Factory default: root. Cannot be null. After the first login in using the factory default settings, change the default username/password first, or the user cannot use any other function (designed for data security) except the [Overview] and [Account Setting] (Mouse showing hand shape). Password setting rules: <table border="1" data-bbox="347 1350 1203 1599"> <tr> <td>Password</td> <td> <ol style="list-style-type: none"> 1. Must not be the same as the account. 2. The length must be greater than 6 characters. 3. With English uppercase. 4. With English lowercase. 5. With numbers. </td> </tr> </table>	Password	<ol style="list-style-type: none"> 1. Must not be the same as the account. 2. The length must be greater than 6 characters. 3. With English uppercase. 4. With English lowercase. 5. With numbers.
Password	<ol style="list-style-type: none"> 1. Must not be the same as the account. 2. The length must be greater than 6 characters. 3. With English uppercase. 4. With English lowercase. 5. With numbers. 		
Confirm Password	Retype the password for the operation conform when setting the new account information.		
Save	Click to save the settings of this page.		

4.1.5 Web Server Setting

Function: Provide Web Server settings, such as display and set the Web Server port.

Support Module: All UA I/O modules support this function, both Http and Https can be enabled.

Manu Path: 【 System Setting 】 → 【 Web Server Setting 】 System Setting → Web Server Setting
 (Appendix A).

Http Web Server Setting

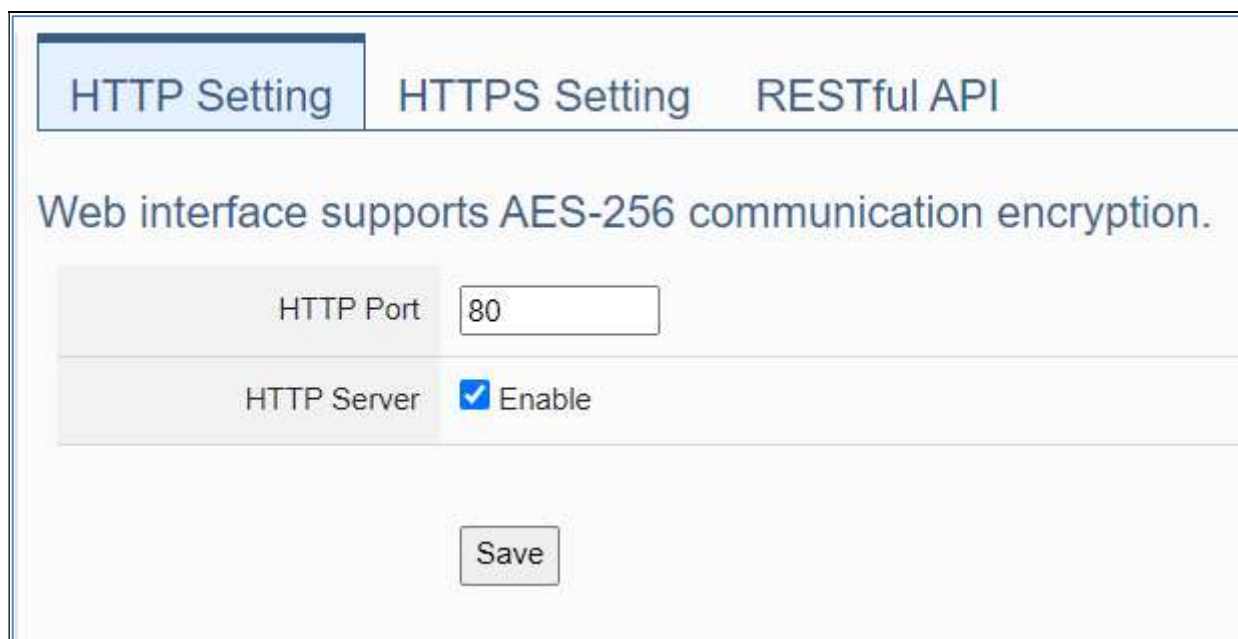

Figure 87 4-1-5 Web Server Setting(1)

Table 43 4-1-5 Web Server Setting

System Setting > Web Server Setting	
HTTP Port	Web Server port of the UA I/O device. Factory default port: 80.
HTTP Server	When Enable is checked, HTTP Server is enabled.
Save	Click to save the settings.

NOTE: After clicking the “save” icon, the system will restart the Web Server. It takes time to start, please wait patiently.

Https Web Server Setting

Figure 88 4-1-5 Web Server Setting(2)

Table 44 4-1-5 Web Server Setting-Basic Setting

System Setting > Web Server Setting - Basic Setting	
HTTPS Port	HTTPS Web Server port of the UA I/O device. Factory default port: 8888.
Certificate	Click the Download button to download the .crt file from the module to the local computer.
HTTPS Server	When Enable is checked, HTTPS Server is enabled.

Table 45 4-1-5 Web Server Setting-Advanced Setting

System Setting > Web Server Setting - Advanced Setting	
Custom Certificate	Customize the server certificate. Filename rules: [A-Z, a-z, 0-9].crt, only .crt files consisting of letters and numbers are accepted.
Custom Private Key	Customize the Private Key. Filename rules: [A-Z, a-z, 0-9].key, only .key files consisting of letters and numbers are accepted.

NOTE: After clicking the “save” icon, the system will restart the Web Server. It takes time to start, please wait patiently.

RESTful API

The screenshot shows a web interface for configuring the RESTful API. At the top, there are three tabs: 'HTTP Setting', 'HTTPS Setting', and 'RESTful API', with the latter being the active tab. Below the tabs, the 'Request Method' is set to 'GET /Design'. On the right side, there is a link labeled 'Example'. The main area contains a 'Custom Format' section with a dropdown menu labeled 'Select a channel' and an 'Insert' button. Below the dropdown are 'Edit' and 'Preview' buttons. A large text area for entering the custom format is located below these buttons. At the bottom of the interface, there are 'Save' and 'Test' buttons.

Figure 89 4-1-5 RESTful API-Request Method GET/Design

Table 46 4-1-5 RESTful API-Request Method GET/Design

System Setting > Web Server Setting – Request Method Get / Design	
Custom Format	<p>Please click on the "Examples" button on the top right corner of the page for detailed instructions.</p> <p>Step 1: Select the channel and click the Insert button. Insert the identifier into the edit box.</p> <p>Step 2: Click the Edit button to customize the content.</p> <p>Step 3: Click the Preview button to check if the customized content is correct.</p> <p>Step 4: Click the Save button to save the setting.</p> <p>Step 5: Click the Test button to test if the format is correct.</p>

Figure 90 4-1-5 RESTful API-Request Method PUT/Design

Table 47 4-1-5 RESTful API-Request Method PUT/Design

System Setting > Web Server Setting – Request Method PUT / Design	
Custom Format	<p>Please click on the " Examples " button on the top right corner of the page for detailed instructions.</p> <p>Step 1: Select the channel and click the Insert button. Insert the identifier into the edit box.</p> <p>Step 2: Click the Edit button to customize the content.</p> <p>Step 3: Click the Preview button to check if the customized content is correct.</p> <p>Step 4: Click the Save button to save the setting.</p>

Table 48 4-1-5 RESTful API-Test Setting

System Setting > Web Server Setting - Test Setting	
Enter Test Data	<p>Step 1: Copy the customized content and enter it into the edit box.</p> <p>Step 2: Change the identifier of the customized content to a value.</p>
Test Data	<p>Step 1: Click the Send button</p> <p>Step 2: Check if the I/O channel value has changed.</p>

4.1.6 Firewall Setting

Function: Provide firewall settings, allowing specific IP to have permission to connect to the module.

Support Module: All UA I/O modules support this function.

Manu Path: 【System Setting】 → 【Firewall Setting】 System Setting → Firewall Setting ([Appendix A](#)).

Allow Remote Device Connection

Allow All IP	<input type="checkbox"/> Enable
Allow IP	<input style="width: 100%;" type="text"/>
Allow IP	<input style="width: 100%;" type="text"/>
Allow IP	<input style="width: 100%;" type="text"/>
Allow IP Range	<div style="display: flex; justify-content: space-between;"> <input style="width: 45%; border: 1px solid #ccc;" type="text" value="Start Address"/> <input style="width: 45%; border: 1px solid #ccc;" type="text" value="End Address"/> </div>

Figure 91 4-1-6 Firewall Setting

Table 49 4-1-6 Firewall Setting

System Setting > Firewall Setting	
Allow all IP	Check the box to allow all IPs to connect to UA-I/O. Factory default value: Enabled.
Allow IP	Enter the IP to allow a specific IP to connect to UA-I/O. Limit the number of IP connections: Up to 3 sets of client computer or device IP.
Allow IP zones	Allow UA-I/O connection for specific IP zones

4.1.7 Firmware Setting

Function: Provide firmware settings, such as restore factory setting and update firmware.

Support Module: All UA I/O modules support this function.

Manu Path: 【System Setting】 → 【Firmware Setting】 System Setting → Firmware Setting (Appendix A).

Restore Factory Setting

1. Check the “Enable” box to enable the “Restore” button, and then click on the “Restore” button to start the restore operation.

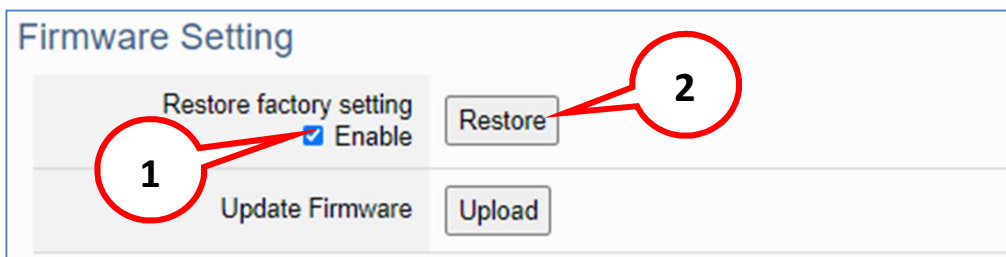

Figure 92 4-1-7 Restore factory setting(1)

2. A message will prompt appear, showing the installation process of the restore program.

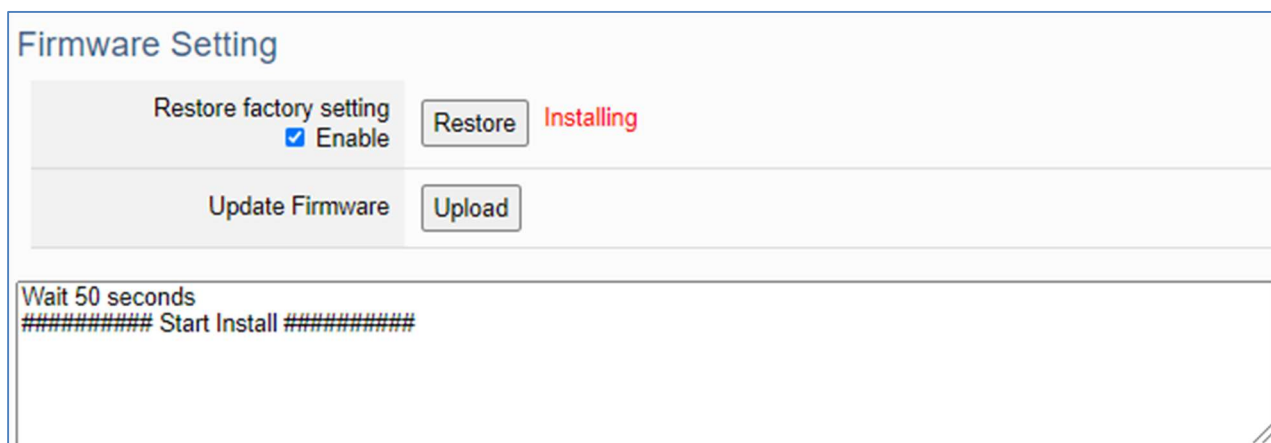

Figure 93 4-1-7 Restore factory setting(2)

- After the process finished, it appears a box message "During device restart, after waiting for 60 seconds, press OK", indicating that **this restoration succeeds**. If the box does not pop up, **this restoration fails**.

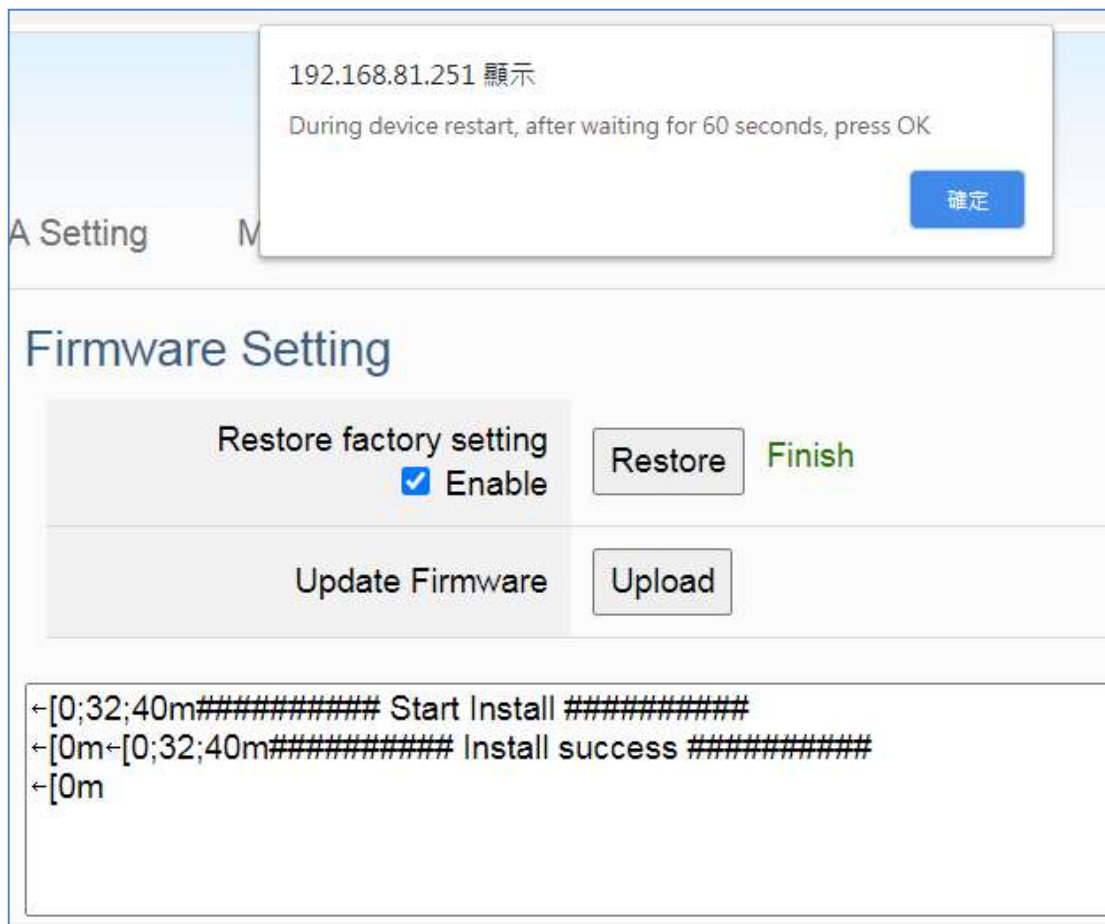

Figure 94 4-1-7 Restore factory setting(3)

- After restarting, the module will restore the factory default settings as follows: (Web IP address automatically changes to 192.168.255.1)

Table 50 4-1-7 Factory Default Settings of UA I/O Modules

Factory Default Settings of UA I/O Modules			
Network	IP (LAN)	192.168.255.1	Assign UA I/O a new IP setting according to your case.
	Netmask	255.255.0.0	
	Gateway	192.168.1.1	
Web UI Account	Username	root	After login, change the default username/password to use other functions.
	Password	root	

Update Firmware

When UA I/O has new functions, users can go to the UA series download center on the ICP DAS website to download the latest version of Firmware software, and then update the firmware of your UA I/O module according to the steps in this section.

UA series download center on the ICP DAS website:

<https://www.icpdas.com/en/download/index.php?nation=US&kind1=&model=&kw=ua->

1. Click on the “Upload” button

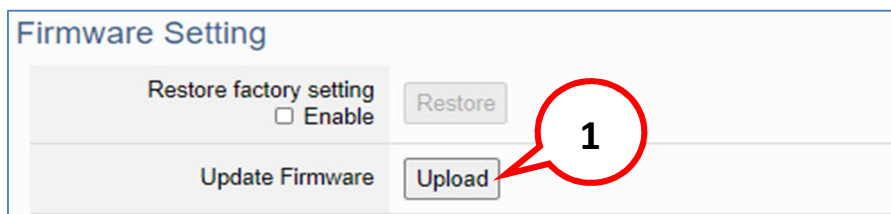

Figure 95 4-1-7 Update Firmware(1)

2. Select the firmware file

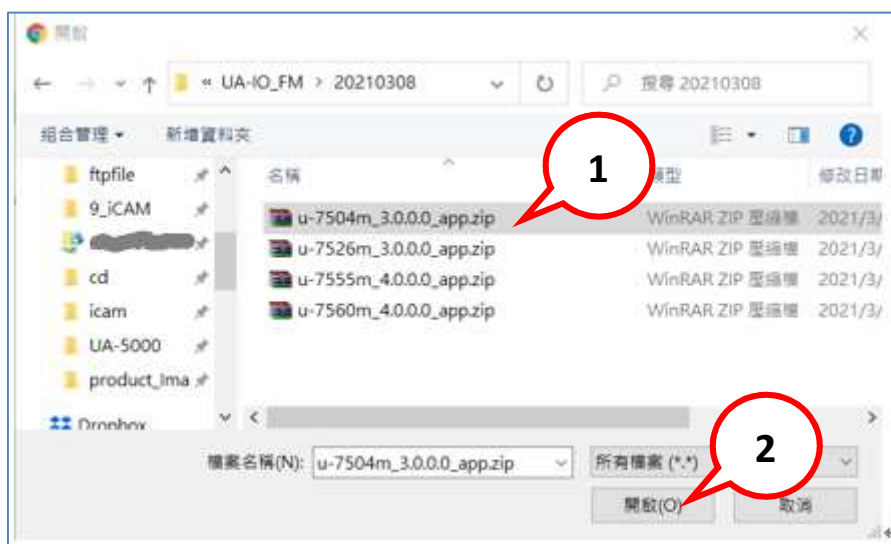

Figure 96 4-1-7 Update Firmware(2)

3. Begin to upload the Firmware file, and the lower message box will show the progress.

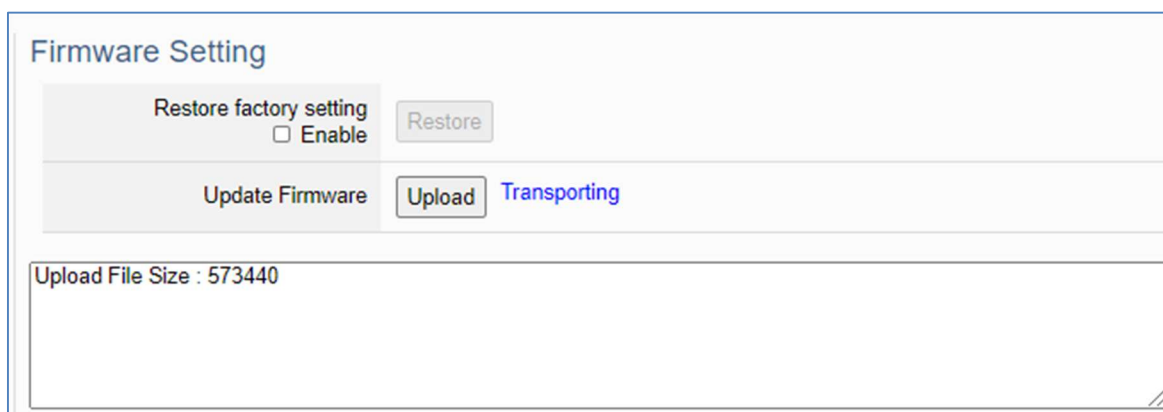

Figure 97 4-1-7 Update Firmware(3)

4. After uploading the file, it begins to install the firmware.

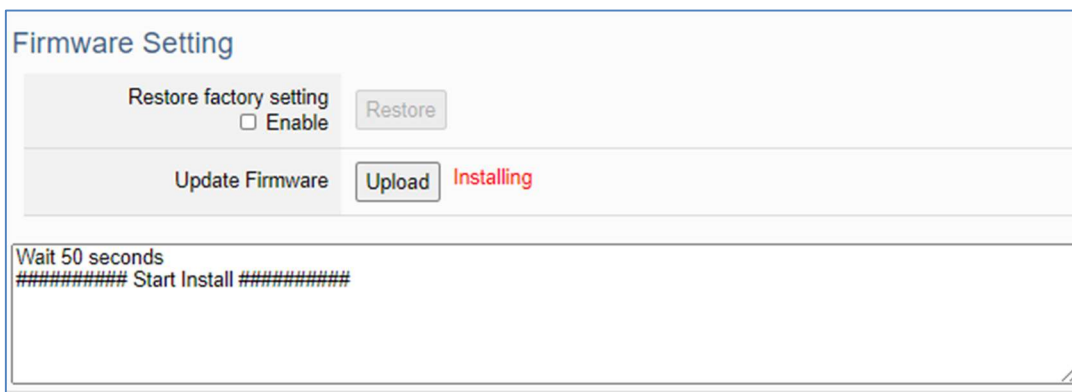

Figure 98 4-1-7 Update Firmware(4)

5. After the process is finished, it appears a box message "During device restart, after waiting for 60 seconds, press OK", indicating that **this update succeeds**. If the box does not pop up, **this update fails**.

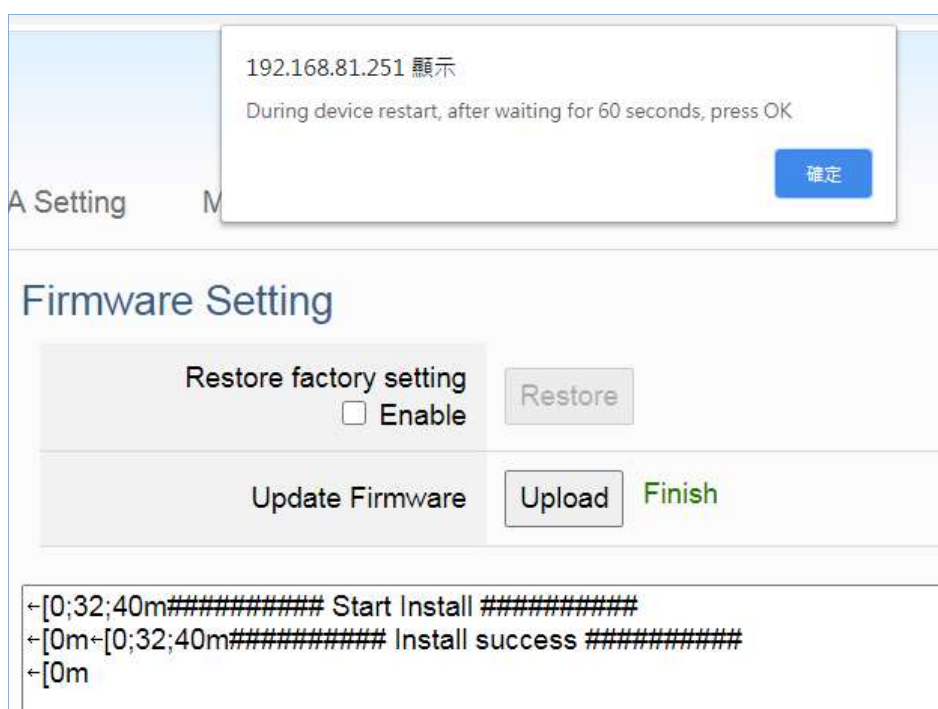

Figure 99 4-1-7 Update Firmware(5)

6. After restarting, the module will recover the UA I/O settings as follows:

Table 51 4-1-7 Update Firmware

Update Firmware of UA I/O Modules			
Network	IP (LAN)	Keep the original setting	Assign UA I/O a new IP setting according to your case.
	Netmask	Keep the original setting	
	Gateway	Keep the original setting	
Web UI Account	Username	root	After login, change the default username/password to use other functions.
	Password	root	

Maintenance

This function is only provided to ICP DAS R&D personnel for maintenance using. It is reserved and not open for use.

Maintenance

R&D Maintenance	<input type="button" value="OK"/>
<input type="button" value="Ping"/>	<input style="width: 100%;" type="text" value="IP Address"/>
Message	<div style="border: 1px solid #ccc; height: 100px; width: 100%;"></div>

Figure 100 4-1-7 Maintenance

4.2 Main Menu - Module Setting

This main menu aggregates all modules and projects in the module-related function settings. This chapter focuses on parameter descriptions. For the detailed steps and notices for using OPC UA connection/certificate, please refer to [3.1 Settings for Using OPC UA Connection](#) of [Chapter 3 Main Function Settings](#).

4.2.1 Overview

Function: Provides the status of the I/O functions, and a common settings table for download.

Support Module: All UA I/O modules support this function.

Manu Path: 【Module Setting】 → 【Overview】 Module Setting → Overview (Refer to [Appendix A](#))

Function Overview

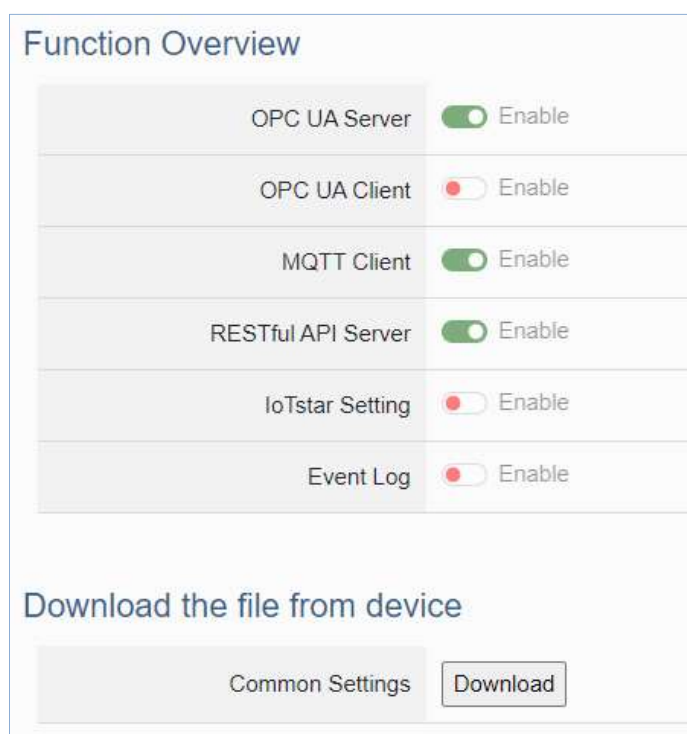

Figure 101 4-2-1 Function Overview

Table 52 4-2-1 Function Overview

Module Setting > Overview > Function Overview	
OPC UA Server	Display the OPC UA Server enable status.
OPC UA Client	Display the OPC UA Client enable status.
MQTT Client	Display the MQTT Client enable status.
RESTful API Server	Display the RESTful API Server enable status.
IoTstar Setting	Display the IoTstar Client enable status.
Event Log	Display the Event Log enable status.

Download the file from device

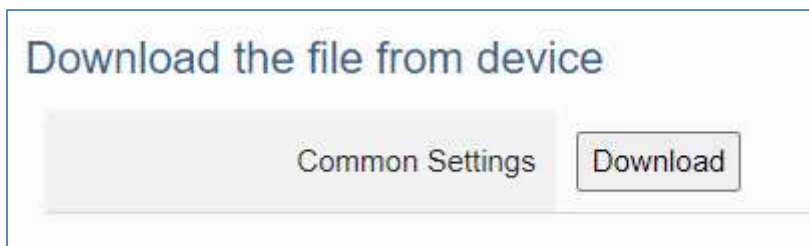

Figure 102 4-2-1 Download the file from device

Table 53 4-2-1 Download the file from device

Module Setting > Overview > Download the file from device	
Common Settings	Press the Download button to get the common settings table. Example reference: For a simple setup example, please refer to Section 3.4 .

4.2.2 I/O Setting

Function: Display and change the I/O settings of the UA I/O module.

Support Module: All UA I/O modules support this function, Http, and Https, both can be enabled.

Manu Path: 【 Module Setting 】 → 【 I/O Setting 】 Module Setting → I/O Setting (Appendix A).

Digital Input

Digital Input

Channel	Nickname	OPC UA Description	Counter Clear	Counter Preset
DI0	<input style="width: 100%;" type="text" value="一樓警報指示燈"/>	<input style="width: 100%;" type="text"/>	<input type="checkbox"/>	<input style="width: 50%;" type="text" value="0"/>
DI1	<input style="width: 100%;" type="text" value="二樓警報指示燈"/>	<input style="width: 100%;" type="text"/>	<input type="checkbox"/>	<input style="width: 50%;" type="text" value="0"/>

Figure 103 4-2-2 I/O Setting-Digital Input

Table 54 4-2-2 I/O Setting-Digital Input

Module Setting > I/O Setting - Digital Input	
Channel	The channel name (number) of the UA I/O hardware.
Nickname	The identification name of the channel for easy identification
OPC UA Description	The messages got from the description column of the OPC Client when using an OPC UA connection.
Counter Clear	Counter reset to zero
Counter Preset	The count starts from this set value after powering on, and the count will return to zero after the module is powered off.

Digital Output

Digital Output

Channel	Nickname	OPC UA Description	Power on Value
DO0	<input type="text" value="A棟大門"/>	<input type="text"/>	<input type="checkbox"/>
DO1	<input type="text" value="B棟大門"/>	<input type="text"/>	<input type="checkbox"/>

Figure 104 4-2-2 I/O Setting-Digital Output

Table 55 4-2-2 I/O Setting-Digital Output

Module Setting > I/O Setting - Digital Output	
Channel	The channel name (number) of the UA I/O hardware.
Nickname	The identification name of the channel for easy identification
OPC UA Description	The messages got from the description column of the OPC Client when using an OPC UA connection.
Power-on Value	After the power is turned off and restarted, the startup value of I/O, if checked, the boot output will output True, otherwise, it will output False.

Analog Input

Analog Input

Channel	Nickname	OPC UA Description	Input Type	Enable
Vin0	<input type="text" value="Vin0"/>	<input type="text"/>	-10 ~ 10 V ▼	<input checked="" type="checkbox"/>
Vin1	<input type="text" value="Vin1"/>	<input type="text"/>	-10 ~ 10 V ▼	<input checked="" type="checkbox"/>
Vin2	<input type="text" value="Vin2"/>	<input type="text"/>	-10 ~ 10 V ▼	<input checked="" type="checkbox"/>
Vin3	<input type="text" value="Vin3"/>	<input type="text"/>	-10 ~ 10 V ▼	<input checked="" type="checkbox"/>
Vin4	<input type="text" value="Vin4"/>	<input type="text"/>	-10 ~ 10 V ▼	<input checked="" type="checkbox"/>
Vin5	<input type="text" value="Vin5"/>	<input type="text"/>	-10 ~ 10 V ▼	<input checked="" type="checkbox"/>

Figure 105 4-2-2 I/O Setting-Analog Input

Table 56 4-2-2 I/O Setting-Analog Input

Module Setting > I/O Setting – Analog Input	
Channel	The channel name (number) of the UA I/O hardware.
Nickname	The identification name of the channel for easy identification
OPC UA Description	The messages got from the description column of the OPC Client when using an OPC UA connection.
Input Type	Select the Input type by user’s need.
Enable	Set the analog input channels individually to enable or disable.

Analog Output

Analog Output

Channel	Nickname	OPC UA Description	Power-on Value	Output Type
Vout0	<input type="text" value="Vout0"/>	<input type="text" value="AO_0"/>	<input type="text" value="0"/>	<input style="border: none; background-color: #f0f0f0; padding: 2px 5px; font-size: small; font-weight: bold; text-align: center; width: 100%;" type="text" value="-5 ~ 5 V"/>
Vout1	<input type="text" value="Vout1"/>	<input type="text"/>	<input type="text" value="0"/>	<input style="border: none; background-color: #f0f0f0; padding: 2px 5px; font-size: small; font-weight: bold; text-align: center; width: 100%;" type="text" value="0 ~ 10 V"/>

Figure 106 4-2-2 I/O Setting-Analog Output

Table 57 4-2-2 I/O Setting-Analog Output

Module Setting > I/O Setting – Analog Output	
Channel	The channel name (number) of the UA I/O hardware.
Nickname	The identification name of the channel for easy identification
OPC UA Description	The messages got from the description column of the OPC Client when using an OPC UA connection.
Power-on Value	The initial value of the I/O channel after the power off and restart to on.
Output Type	Select the Output type by user’s need.

4.2.3 Scaling

Function: The Setting of scaling converts the analog signal to a more readable value. This function is only available for modules with AI/AO.

Support Module: All UA AI/AO modules support this function.

Manu Path: 【 Module Setting 】 → 【 Scaling 】 Module Setting → Scaling (Appendix A).

When the variable value needs to be scaled or converted before output. Fill in the Min/Max items of the Source/Output Variable, and add a description, the Scaling conversion function will be activated.



Figure 107 4-2-3 Module Setting-Scaling

Table 58 4-2-3 Module Setting-Scaling

Module Setting > Scaling – Content Setting	
Nickname(Source variable)	The Nickname in the function of [Module Setting] → [I/O Setting]
Min (Source variable)	The source variable that is to be converted; Fill in its minimum value.
Max (Source variable)	The source variable that is to be converted; Fill in its maximum value.
Min (Output variable)	The output variable that is to be converted; Fill in its minimum value.
Max (Output variable)	The output variable that is to be converted; Fill in its maximum value.
Offset (output variable)	Output variable + Offset = Actual Value

4.2.4 I/O Status

Function: Display and change the I/O status of the UA I/O module.

Support Module: All UA I/O modules support this function.

Manu Path: 【 Module Setting 】 → 【 I/O Status 】 Module Setting → I/O Status (Appendix A).

Digital Input (& Counter)

Digital Input			
Channel	Nickname	Value	Status
DI0	一樓警報指示燈	<input type="checkbox"/>	GOOD
DI1	二樓警報指示燈	<input type="checkbox"/>	GOOD
DI0_Counter	一樓警報指示燈_Counter	<input type="text" value="0"/>	GOOD
DI1_Counter	二樓警報指示燈_Counter	<input type="text" value="0"/>	GOOD

Figure 108 4-2-4 I/O Status-Digital Input

Table 59 4-2-4 I/O Status-Digital Input

Module Setting > I/O Status - Digital Input	
Channel	The channel name (number) of the UA I/O hardware.
Nickname	The Nickname in the function of [Module Setting] → [I/O Setting]
Value	Current channel status value. When the value changes, the signal LED will change.
Status	GOOD, BAD, or UNCERTAIN.

Digital Output

Digital Output			
Channel	Nickname	Value	Status
DO0	<input type="text" value="A棟大門"/>	<input checked="" type="checkbox"/>	GOOD
DO1	<input type="text" value="B棟大門"/>	<input type="checkbox"/>	GOOD

Figure 109 4-2-4 I/O Status-Digital Output

Table 60 4-2-4 I/O Status-Digital Output

Module Setting > I/O Status - Digital Output	
Channel	The channel name (number) of the UA I/O hardware.
Nickname	The Nickname in the function of [Module Setting] → [I/O Setting]
Value	Current channel status value. When the value changes, the signal LED will change.
Status	GOOD, BAD, or UNCERTAIN.

Analog Input

Analog Input				
Channel	Nickname	Value	Status	Input Type
Vin0	<input type="text" value="Vin0"/>	<input type="text" value="0"/>	GOOD	-10 ~ 10 V ▾
Vin1	<input type="text" value="Vin1"/>	<input type="text" value="0"/>	GOOD	-10 ~ 10 V ▾
Vin2	<input type="text" value="Vin2"/>	<input type="text" value="0"/>	GOOD	-10 ~ 10 V ▾
Vin3	<input type="text" value="Vin3"/>	<input type="text" value="0"/>	GOOD	-10 ~ 10 V ▾

Figure 110 4-2-4 I/O Status-Analog Input

Table 61 4-2-4 I/O Status-Analog Input

Module Setting > I/O Status – Analog Input	
Channel	The channel name (number) of the UA I/O hardware.
Nickname	The Nickname in the function of [Module Setting] → [I/O Setting]
Value	Current channel status value. When the input type is 4-20mA, if an abnormal state occurs, the value will display as -32.768.
Status	GOOD, BAD, or UNCERTAIN.

Input type	Display Value	Anomalous narrative
4~20mA	-32.768	Signal source disconnected

Analog Output

Channel	Nickname	Value	Status	Output Type
Vout0	<input type="text" value="Vout0"/>	<input type="text" value="0"/>	GOOD	-5 ~ 5 V ▾
Vout1	<input type="text" value="Vout1"/>	<input type="text" value="0"/>	GOOD	0 ~ 10 V ▾

Figure 111 4-2-4 I/O Status-Analog Output

Table 62 4-2-4 I/O Status-Analog Output

Module Setting > I/O Status - Analog Output	
Channel	The channel name (number) of the UA I/O hardware.
Nickname	The Nickname in the function of [Module Setting] → [I/O Setting]
Value	Current channel status value.
Status	GOOD, BAD, or UNCERTAIN.

4.2.5 Project File

Function: download and upload the project file of the UA I/O module.

Support Module: All UA I/O modules support this function.

Manu Path: 【 Module Setting 】 → 【 Project File 】 Module Setting → Project File (Appendix A).

Download the file from device

APP Project File: Easy to copy the APP settings of this UA-I/O to other UA-I/Os.

APP Project File + System Settings: When this UA-I/O fails, the same UA-I/O can be copied immediately by uploading the AllSetting file.

Click the [Download] button to download the file to your computer.

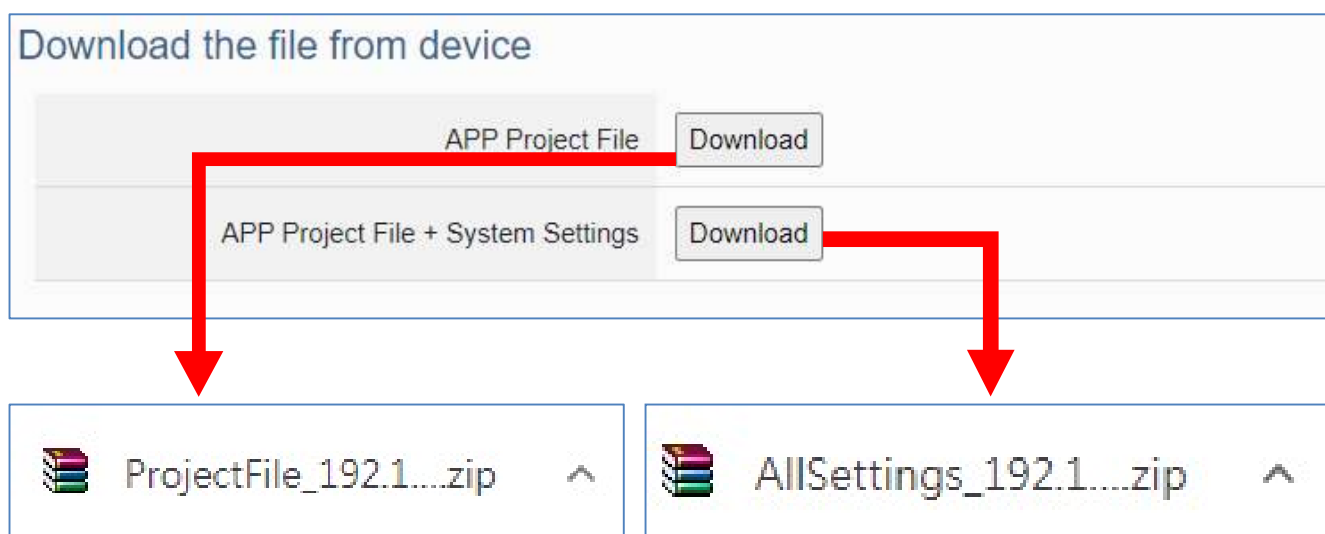

Figure 112 4-2-5 Download the file from device(1)

Upload the file to the device

Upload the "ProjectFile_xxx_.zip" file to replace the backed-up project file, then you can restore the project parameters.

Click [Upload] button, select the project file in the PC.

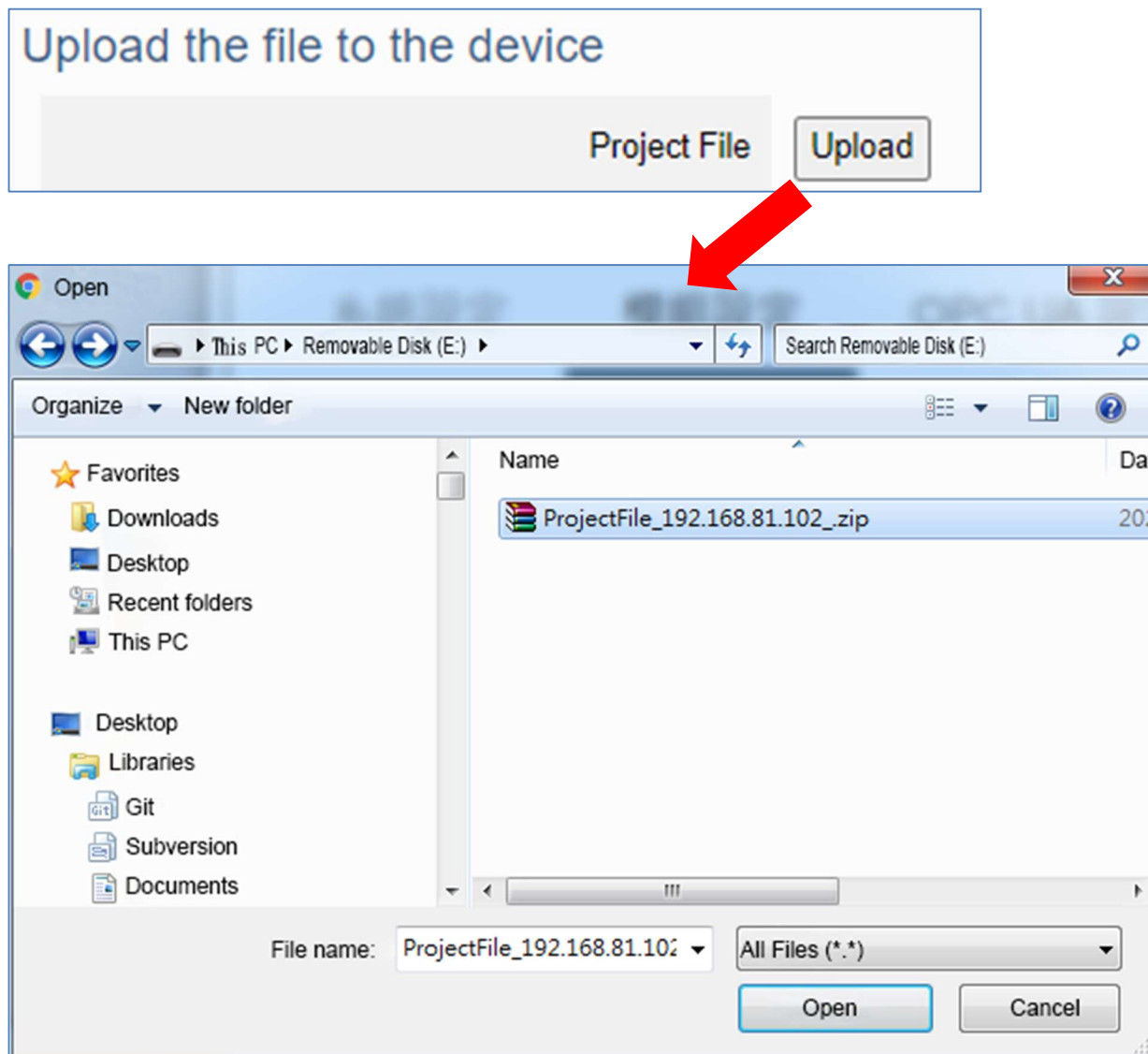

Figure 113 4-2-5 Download the file from device(2)

Upload the "AllSettings_xxx_.zip" file to restore all previous UA-I/O settings.

Click the [Upload] button, and select the project file to be uploaded.

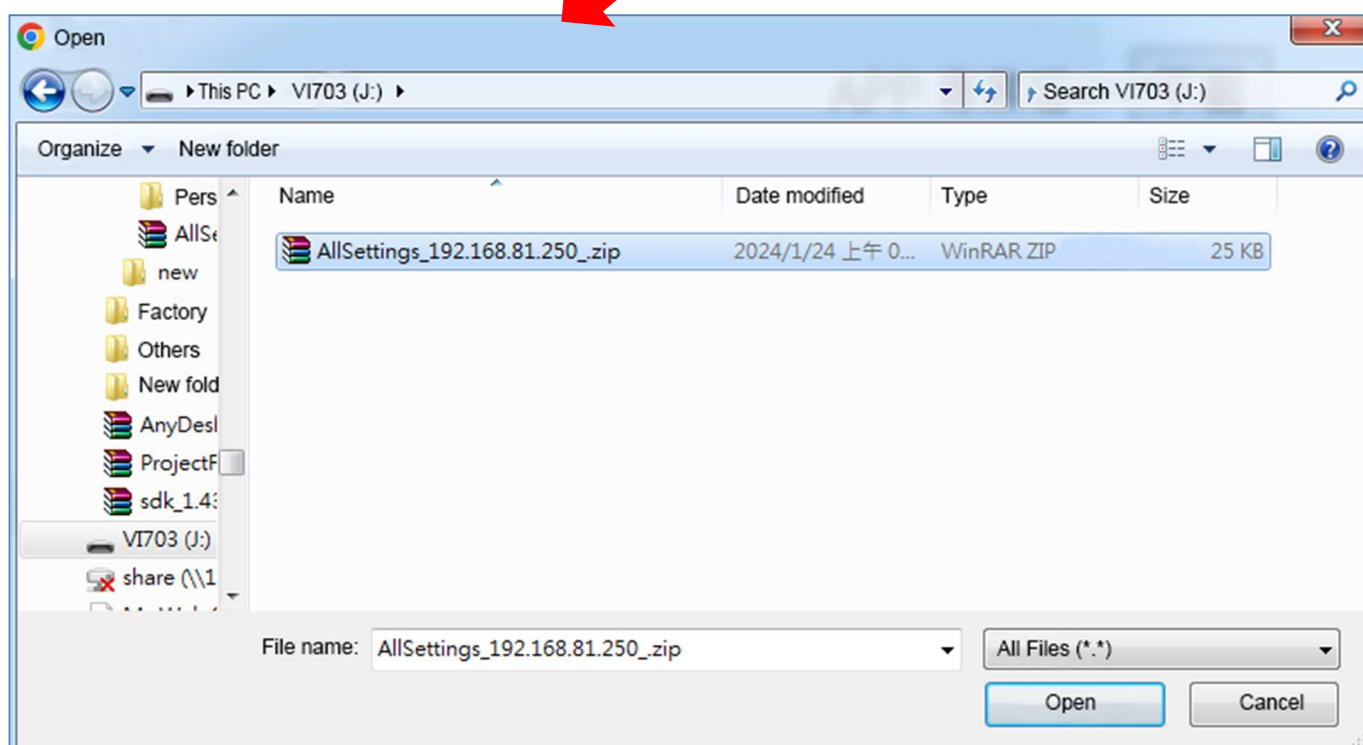
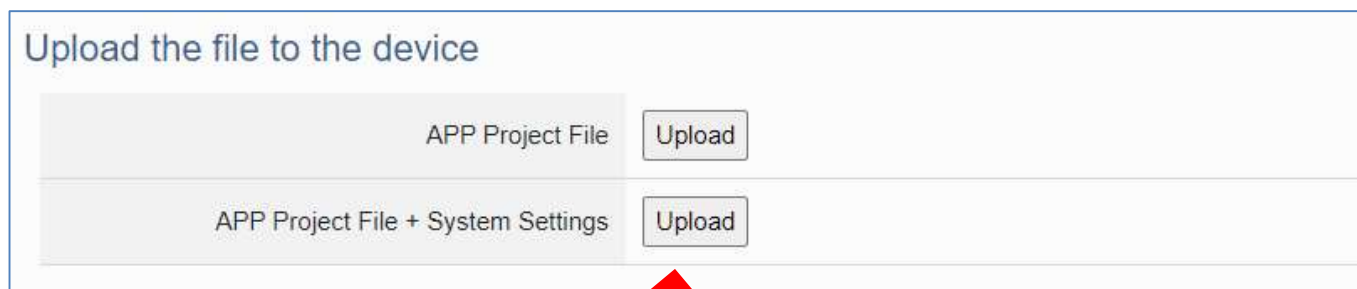

Figure 114 4-2-5 Download the file from device(3)

4.3 Main Menu - OPC UA Setting

This main menu aggregates all OPC UA related settings. This chapter focuses on parameter descriptions. About the detailed steps and notices for using OPC UA connection/certificate, please refer to [3.1 Settings for Using OPC UA Connection](#) of [Chapter 3 Main Function Settings](#).

NOTE:

When the main menu “**OPC UA Setting**” has a message of “[Please remove the server certificate](#)” (as the picture below), that means there is something error about the server certificate file.

Please click the menu **【OPC UA Setting】** → **【Certificate】**  →  ([Appendix A](#)) to remove the Server Certificate, the function of OPC UA menu will be normal again.

The operation to remove the Server Certificate, please refer to the next two section “[4.3.2 Certificate](#)”.

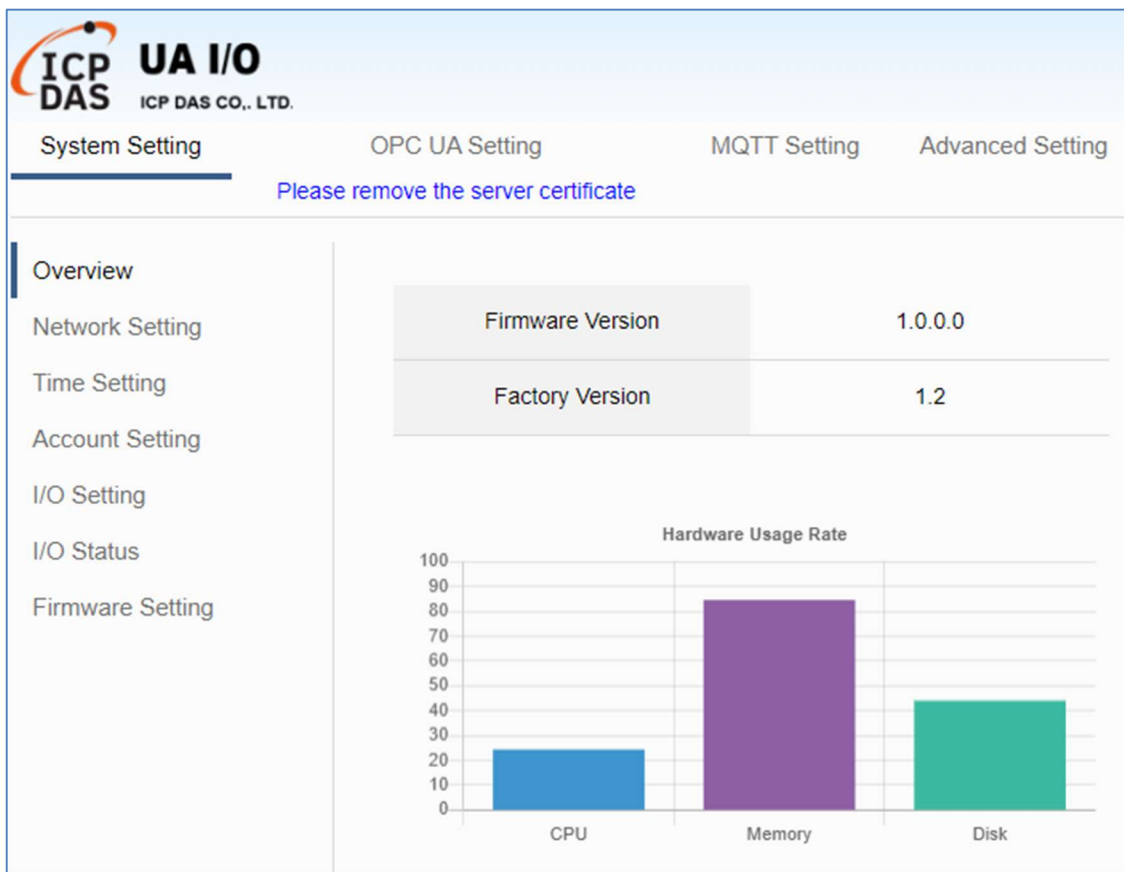

Figure 115 4-3 OPC UA Setting-Please remove the server certiiicate

4.3.1 Server Setting

Function: Provide the Server settings for using the OPC UA connection.

Support Module: All UA I/O modules support this function.

Manu Path: 【OPC UA Setting】 → 【Server Setting】 OPC UA Setting → Server Setting (Appendix A).

Sample: For a simple setting example, please refer to [Section 3.1](#) .

The OPC UA Server supports IPv4 only.

Connection Settings

Port

Login

Anonymous Login	<input checked="" type="checkbox"/> Enable
Username Password Login	<input checked="" type="checkbox"/> Enable <div style="display: flex; justify-content: space-between; margin-top: 5px;"> <input style="width: 150px;" type="text" value="Username root"/> <input style="width: 100px;" type="password" value="Password ****"/> </div>
Certificate Login	<input type="checkbox"/> Enable

Security

	Security Policy	Security Mode
Security Settings	<input checked="" type="checkbox"/> None	
	<input checked="" type="checkbox"/> Basic128Rsa15	<input type="text" value="Sign, Sign and Encrypt"/> ▾
	<input checked="" type="checkbox"/> Basic256	<input type="text" value="Sign, Sign and Encrypt"/> ▾
	<input type="checkbox"/> Basic256Sha256	<input type="text" value="Sign, Sign and Encrypt"/> ▾
	<input type="checkbox"/> Aes128Sha256RsaOaep	<input type="text" value="Sign, Sign and Encrypt"/> ▾
	<input type="checkbox"/> Aes256Sha256RsaPss	<input type="text" value="Sign, Sign and Encrypt"/> ▾
Automatically Trust all client certificates	<input checked="" type="checkbox"/> Enable	

Figure 116 4-3-1 Server Setting-Connection Settings

Table 63 4-3-1 Server Setting-Connection Settings

OPC UA Setting > Server Setting - Connection Setting		
Port	The communication port number of the OPC UA Server. System Default: 48010.	
Anonymous Login	Check to enable the anonymous login from OPC UA clients.	
Username Password Login	Check to enable the user password login from OPC UA clients. The following are the defaults for username and password: Username: root Password: root	
Certificate Login	Check to enable the certificate login from OPC UA clients. (refer to next section, Server Certificate)	
Security Setting	Security Policy	Security Mode
	None	
	Basic128Rsa15	Sign, Sign and Encrypt
	Basic256	Sign, Sign and Encrypt
	Basic256Sha256	Sign, Sign and Encrypt
	Aes128Sha256RsaOaep	Sign, Sign and Encrypt
	Aes256Sha256RsaPss	Sign, Sign and Encrypt
Automatically Trust all client certificates	Set this item to true if the OPC UA Client requires only the security policy but doesn't need to exchange certificates when connecting. Set this item to false if you need to exchange certificates. Default: true	
Save	Click to save the connection settings of the OPC UA Server.	

4.3.2 Server Certificate

Function: When selecting the OPC UA certificate connection, the UA I/O (Server side) needs to exchange the certificate with the connecting client side. This page is about setting the OPC UA Certificate for security and encryption, e.g. upload, download, delete the certificate.

Support Module: All UA I/O modules support this function.

Manu Path: 【 OPC UA Setting 】 → 【 Server Certificate 】 OPC UA Setting → Server Certificate ([Appendix A](#)).

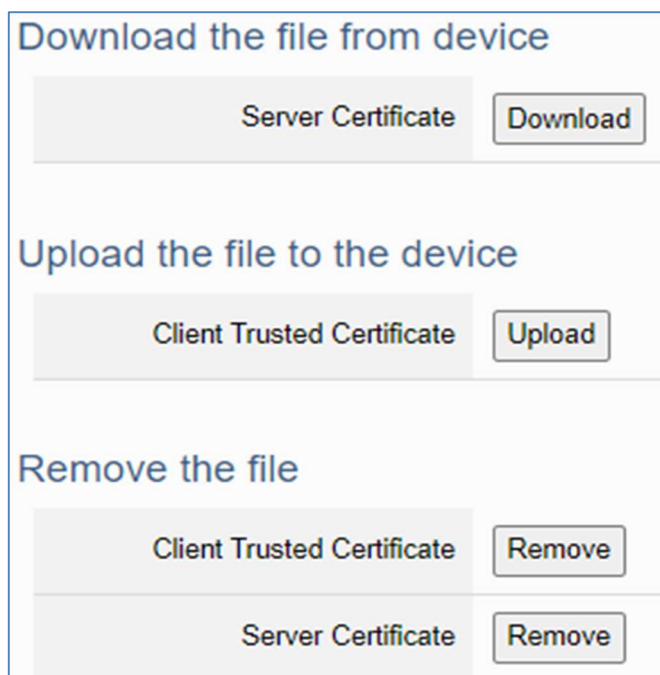

Figure 117 4-3-2 Server Certificate

Table 64 4-3-2 Server Certificate

OPC UA Setting > Server Certificate – Download the file from device	
Server Certificate	Click “Download” to download the OPC UA Server Certificate file to the PC for the use of the client-side device. File Name: icpdasuserver.der
OPC UA Setting > Server Certificate –Upload the file to the device	
Client Trusted Certificate	Click “Upload” to select the OPC UA Client Trusted Certificate file on your PC, and upload the Trusted Certificate file to the UA I/O module. File extension: .der , .cer , and .crt . only
OPC UA Setting > Server Certificate – Remote the file	
Client Trusted Certificate	Click “Remove” to delete all Client Trusted Certificate files.
Server Certificate	Click “Remove” to delete all Server Certificate files.

4.3.3 Client Setting

Function: The OPC UA Client connection settings.

Support Module: All UA I/O modules support this function.

Manu Path: 【OPC UA Setting】 → 【Client Setting】 OPC UA Setting → Client Setting (Appendix A).

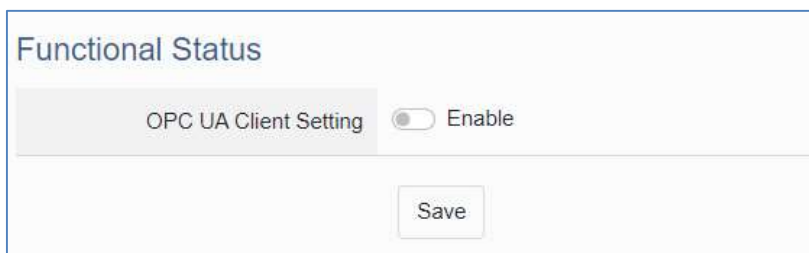

Figure 118 4-3-3 Client Setting-Functional Status

Table 65 4-3-3 Client Setting-Functional Status

OPC UA Setting > Client Setting - Functional Status	
OPC UA Client	To use this function, select Enable and click the Save button.

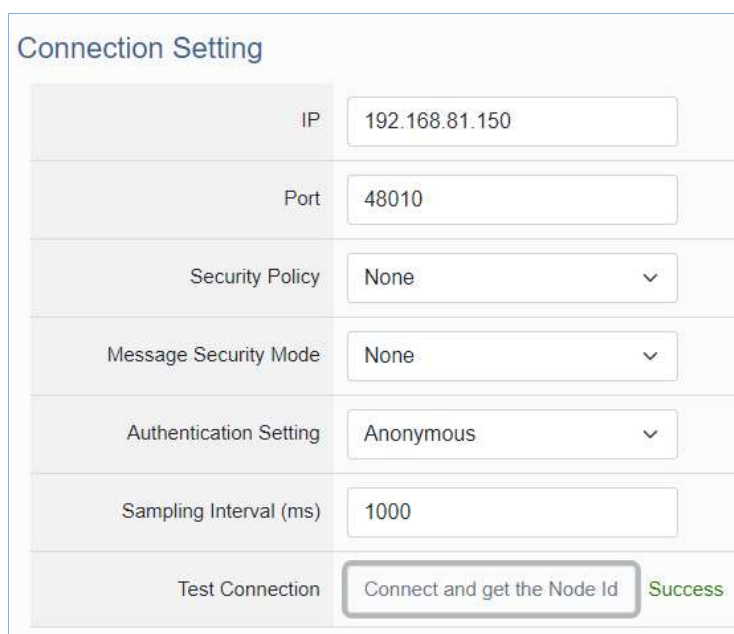

Figure 119 4-3-3 Client Setting-Connection Setting

Table 66 4-3-3 Client Setting-Connection Setting

OPC UA Setting > Client Setting - Connection Setting	
IP	The IP address of the OPC UA Server. (IPv4 only)
Port	The port used by the OPC UA Server.
Security Policy	The security policy to use so that you can secure messages that are read from the OPC-UA source. Choose one of the following: None, Basic128Rsa15, Basic256, Basic256Sha256, Aes128Sha256RsaOaep, Aes256Sha256RsaPss.
Message Security Mode	The message security mode to use to secure connections to the OPC-UA source. Choose one of the following: None, Sign, Sign & Encrypt.
Server Certificate Verify	This item appears when the "Security Policy" option is not None.

	Used to select either to authenticate the uploaded OPC UA Server certificate or not.
Authentication Setting	The client makes the settings for user authentication. Choose one of the following: Anonymous, Username, Password, Certificate, Private Key.
Sampling Interval (ms)	Synchronize the time interval of I/O data so the data of the module and OPC UA Server are synchronized.
Test Connection	Click "Connect and get node Id" to connect to OPC UA Server. Success: You can connect and get the node ID of the Server side. (IdentifierType = String or Numeric only).

Channel	Type	Node Id
DI0	Bool <input type="text" value="v"/>	<input type="text" value="ns=2;s=U-7526M.DI0"/>
DI1	Bool <input type="text" value="v"/>	<input type="text" value="ns=2;s=U-7526M.DI1"/>
DI0_Counter	UInt16 <input type="text" value="v"/>	<input type="text" value="ns=2;s=U-7526M.DI0_Counter"/>
DI1_Counter	UInt16 <input type="text" value="v"/>	<input type="text" value="ns=2;s=U-7526M.DI1_Counter"/>

Figure 120 4-3-3 Client Setting- Connect and get the Node Id

Table 67 4-3-3 Client Setting-Connection Setting

OPC UA Setting > Client Setting – Connection Setting	
Channel	The Nickname in the function of [Module Setting] → [I/O Setting]
Type	Select Data Type. Data Type: Bool, SByte, Int16, Int32, Int64, Byte, UInt16, UInt32, UInt64, Float, Double, String
Node Id	Select the node Id on the OPC UA Server (IdentifierType = String or Numeric only), and synchronize the channel I/O data to the Server.

4.3.4 Client Certificate

Function: When OPC UA Certificates are connected, they need to exchange certificates with each other. The interface provides Certificate Upload, Download, and Remove functions.

Support Module: All UA I/O modules support this function.

Manu Path: 【 OPC UA Setting 】 → 【 Client Certificate 】 OPC UA Setting → Client Certificate (Appendix A).

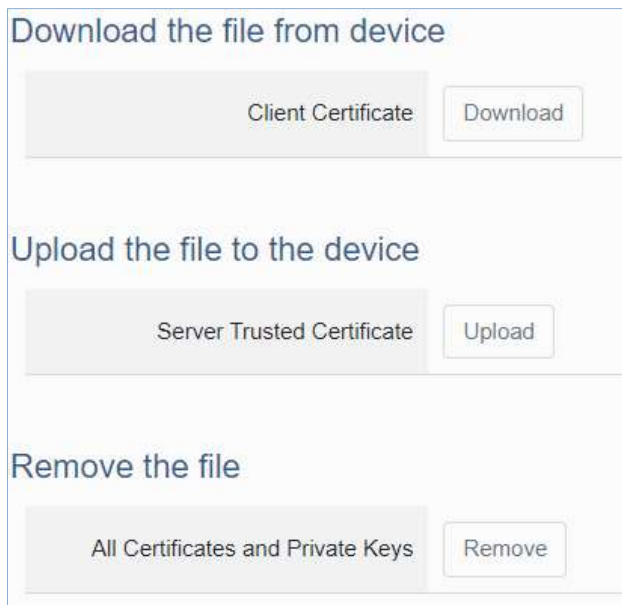

Figure 121 4-3-4 Client Certificate- Download the file from the device

Table 68 4-3-4 Client Certificate- Download the file from the device

OPC UA Setting > Client Certificate – Download the file from device	
Client Certificate	Click “download” to get the Client Certificate. File Name: icpdasuasclient.der.
OPC UA Setting > Client Certificate – Upload the file to the device	
Server Trusted Certificate	Click “Upload” to select the OPC UA Server Trusted Certificate file on your PC. File extension: .der , .cer , and .crt . only
OPC UA Setting > Client Certificate – Remote the file	
All Certificates and Private Keys	Click "Remove" to delete Client Certificates, Server trusted Certificates and. the certificate and private key in the OPC UA setting.

4.4 Main Menu – MQTT Setting

This main menu aggregates all MQTT-related settings. This chapter focuses on parameter descriptions. For the detailed steps and notices for using MQTT connection/certificate, please refer to [3.2 Settings for Using MQTT Connection](#) of [Chapter 3 Main Function Settings](#).

4.4.1 Connection Setting

Function: Provide the remote MQTT Broker settings for using the MQTT connection.

Support Module: All UA I/O modules support this function.

Manu Path: 【 MQTT Setting 】 → 【 Connection Setting 】  →  ([Appendix A](#)).

Sample: For a simple setting example, please refer to [Section 3.2](#) .

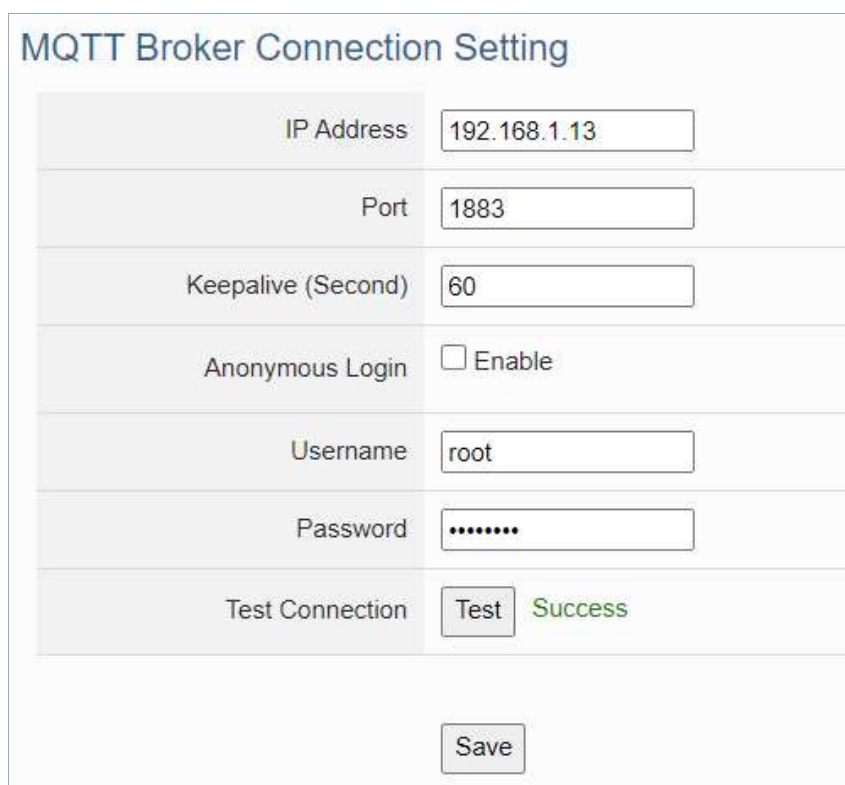

The screenshot shows a web-based configuration page titled "MQTT Broker Connection Setting". It contains several input fields and a checkbox:

- IP Address: 192.168.1.13
- Port: 1883
- Keepalive (Second): 60
- Anonymous Login: Enable
- Username: root
- Password: masked with dots
- Test Connection: A button labeled "Test" with a green "Success" message next to it.
- Save: A button at the bottom of the form.

Figure 122 4-4-1 MQTT Broker Connection Setting

Table 69 4-4-1 MQTT Broker Connection Setting

MQTT Setting > Connection Setting	
IP Address	The IP address of the remote MQTT Broker
Port	The communication port number of the remote MQTT Broker.
Keepalive (Second)	Keep alive detection time. Default: 60
Anonymous Login	When checking the item box, it can connect without a username and password. If not checked, it needs to set a username and password.
Username	The username to login the remote MQTT Broker
Password	The password to login the remote MQTT Broker
Test Connection	Click the Test button to test whether the connection to the MQTT Broker is successful.
Save	Click to save the setting of this page.

4.4.2 Client Setting

Function: Provide the MQTT Client settings for using MQTT connection.

Support Module: All UA I/O modules support this function.

Manu Path: 【 MQTT Setting 】 → 【 Client Setting 】  →  (Appendix A).

Sample: For a simple setting example, please refer to [Section 3.2](#) .

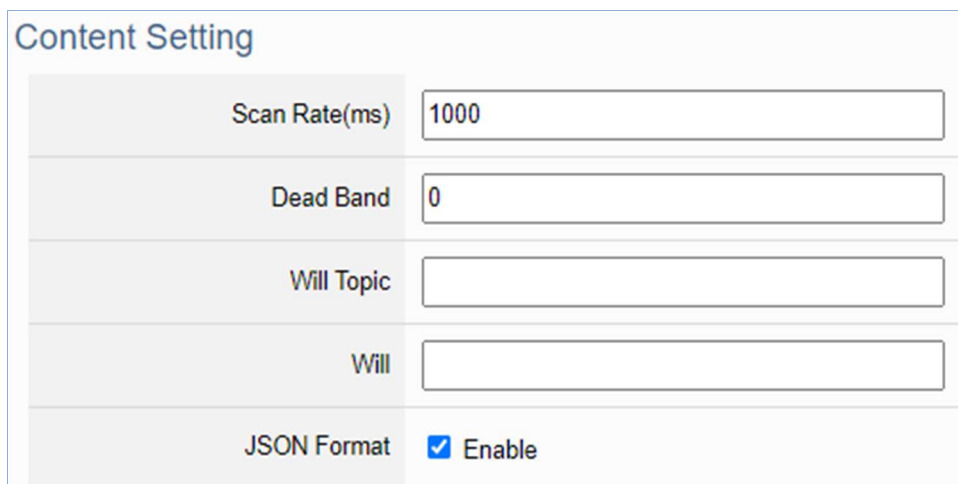

Content Setting	
Scan Rate(ms)	1000
Dead Band	0
Will Topic	
Will	
JSON Format	<input checked="" type="checkbox"/> Enable

Figure 123 4-4-2 Client Setting-Content Setting

Table 70 4-4-2 Client Setting-Content Setting

MQTT Setting > Client Setting – Content Setting	
Update Rate(ms)	Set an update frequency for the task data. Default: 1000 (Unit: ms)
Dead Band	Give a dead bend value for updating a float signal. Default: 0 Dead Band description please refer to Appendix C .
Will Topic	Topic with abnormal disconnection. Default: Null. When the Broker detects that the client is disconnected abnormally, it will publish the Will message to Specified Will Topic. (Topic cannot contain “#”, “+”, and “\$”
Will	Enter a disconnect notice. Default: Null.
JSON Format	Switch the format for sending MQTT messages. If "Enable" is checked, the message will send in groups. For the message format, please refer to Appendix B . If "Enable" is not checked, the message will send in singly.

If the JSON format is checked as "Enable", the message is sent as a group. For its setting items and parameter descriptions, please see the next page.

If the JSON format is not checked, the message is sent in singly. For its setting items and parameter descriptions, please see the page after the next page.

- JSON Format: **Enable** (message is sent as a group):

Publish & Subscribe

Publish Topic	<input type="text" value="/Name/Publish"/>
Publish QoS	<input style="border-bottom: none; border-right: none; border-top: none; border-left: none; width: 100%;" type="text" value="2"/> ▼
Subscribe Topic	<input type="text" value="/Name/Subscribe"/>
Subscribe QoS	<input style="border-bottom: none; border-right: none; border-top: none; border-left: none; width: 100%;" type="text" value="2"/> ▼
Retain	<input style="border-bottom: none; border-right: none; border-top: none; border-left: none; width: 100%;" type="text" value="False"/> ▼

Figure 124 4-4-2 JSON Format-Enable

Table 71 4-4-2 JSON Format-Enable

MQTT Setting > Client Setting - Publish & Subscribe (JSON Format: <input checked="" type="checkbox"/> Enable)	
Publish Topic	The topic of sending data/publishing messages.
Publish QoS	The publish QoS (Quality of Service) levels. Default: 2 0: Delivering a message at most once. 1: Delivering a message at least once. 2: Delivering a message at exactly once.
Subscribe Topic	The topic of receiving data / subscribing messages. It can copy the Publish Topic of the linked device.
Subscribe QoS	The subscribe QoS (Quality of Service) levels. Default: 2 0: Delivering a message at most once. 1: Delivering a message at least once. 2: Delivering a message at exactly once.
Retain	Set up if the Broker retains the message.
Save	Click to save the setting of this page.

- JSON Format: **Not Enable** (message is sent in singly):

JSON Format Enable

Publish & Subscribe

Details Unfold

Nickname	Publish Topic	Subscribe Topic
<input type="text" value="DI0"/>	<input type="text" value="/U-7526M/DI0/Publish"/>	<input type="text"/>
<input type="text" value="DI1"/>	<input type="text" value="/U-7526M/DI1/Publish"/>	<input type="text"/>
<input type="text" value="DI0_Counter"/>	<input type="text" value="/U-7526M/DI0_Counter/Publish"/>	<input type="text"/>
<input type="text" value="DI1_Counter"/>	<input type="text" value="/U-7526M/DI1_Counter/Publish"/>	<input type="text"/>
<input type="text" value="DI0_Preset"/>	<input type="text" value="/U-7526M/DI0_Preset/Publish"/>	<input type="text" value="/U-7526M/DI0_Preset/Subscribe"/>
<input type="text" value="DI1_Preset"/>	<input type="text" value="/U-7526M/DI1_Preset/Publish"/>	<input type="text" value="/U-7526M/DI1_Preset/Subscribe"/>
<input type="text" value="DI0_CounterClear"/>	<input type="text" value="/U-7526M/DI0_CounterClear/Pub"/>	<input type="text" value="/U-7526M/DI0_CounterClear/Sub"/>
<input type="text" value="DI1_CounterClear"/>	<input type="text" value="/U-7526M/DI1_CounterClear/Pub"/>	<input type="text" value="/U-7526M/DI1_CounterClear/Sub"/>
<input type="text" value="DO0"/>	<input type="text" value="/U-7526M/DO0/Publish"/>	<input type="text" value="/U-7526M/DO0/Subscribe"/>

Figure 125 4-4-2 JSON Format-Not Enable

Table 72 4-4-2 JSON Format-Not Enable

MQTT Setting > Client Setting - Publish & Subscribe (JSON Format: <input checked="" type="checkbox"/> Enable)	
Details	Check "Unfold" to display all fields.
Nickname	The Nickname in the function of [Module Setting] → [I/O Setting]
Publish Topic	The topic of sending data / publishing message.
Publish QoS	The publish QoS (Quality of Service) levels. Default: 2 0: Delivering a message at most once. 1: Delivering a message at least once. 2: Delivering a message at exactly once.
Subscribe Topic	The topic of receiving data / subscribing message. It can copy the Publish Topic of linked device.
Subscribe QoS	The subscribe QoS (Quality of Service) levels. Default: 2 0: Delivering a message at most once. 1: Delivering a message at least once. 2: Delivering a message at exactly once.
Save	Click to save the setting of this page.

4.4.3 Certificate

Function: When selecting MQTT certificate connection, the UA I/O needs to exchange the certificate with the connecting device. This page is about setting the MQTT Certificate for the security and encryption.

Support Module: All UA I/O modules support this function.

Manu Path: 【 MQTT Setting 】 → 【 Client Setting 】 MQTT Setting → Client Setting (Appendix A).

1. “SSL/TLS” is not "enable" by default. When not enabled, other setting items will be hidden.

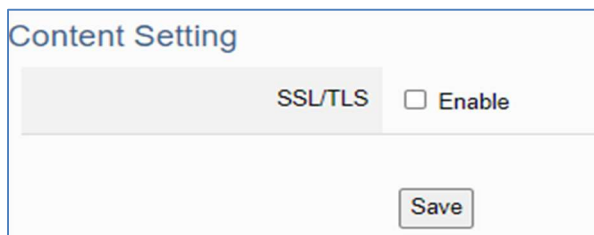
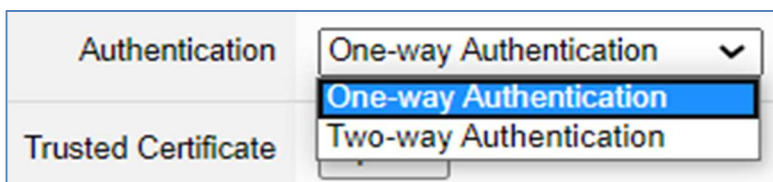

Figure 126 4-4-3 Certificate-SSL/TLS is not enable

Table 73 4-4-3 Certificate-SSL/TLS is not enable

MQTT Setting > Certificate – Content Setting	
SSL/TLS	Check the box and click “Save” to enable the settings for SSL/TLS secure communication. Default: uncheck. The setting items will not appear until clicking the "Save" button.

2. Authentication setting item will show up after enable “SSL/TLS”. Select one way or two way authentication.



One-way authentication: The **Client verifies** the validity of **Broker** credentials.

Two-way authentication: The **Client and Broker verify** the validity of the certificate with **each other**.

This setting page is setting for the MQTT secure encrypted communication (SSL/TLS: Secure Socket Layer / Transport Layer Security). Before setting this function, you need to download or upload the relevant certificates. There are three types of certificates: Trusted Certificate, Certificate, and Private Key. Please upload the files to the UA I/O module according to the type of certificates.

To perform the One-way authentication, you need to upload the Trusted Certificate.

To perform the Two-way authentication, you need to upload the Trusted Certificate first, and then upload the Certificate and Private Key.

Parameter Function Descriptions:

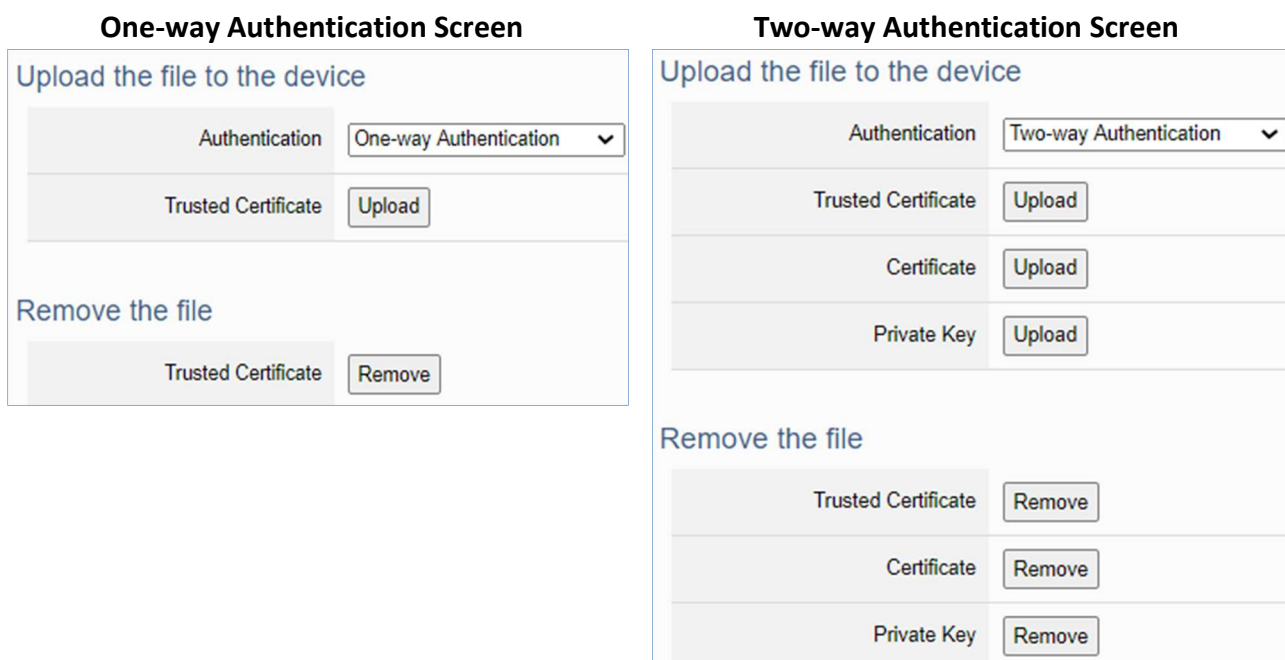

Figure 127 4-4-3 One/Two-way Authentication Screen

Table 74 4-4-3 One/Two-way Authentication Screen

MQTT Setting > Certificate – Upload the file to the device	
Authentication	<p>One-way authentication: The Client verifies the validity of Broker credentials; need to upload the Trusted Certificate.</p> <p>Two-way authentication: The Client and Broker verify the validity of the certificate with each other; need to upload the Trusted Certificate first, and then upload the Certificate and Private Key.</p>
Trusted Certificate	<p>Upload: Click to select the MQTT Trusted Certificate file of the device, and upload the MQTT Trusted Certificate file to the UA I/O module.</p> <ul style="list-style-type: none"> File format must be PEM. Extension name must be “pem”, “cer”, or “crt”.
Certificate	<p>Upload: Click to select the MQTT Certificate file of the device, and upload the MQTT Certificate file to the UA I/O module.</p> <ul style="list-style-type: none"> File format must be PEM. Extension name must be “pem”, “cer”, or “crt”.
Private Key	<p>Upload: Click to select the MQTT Private Key of the device, and upload the MQTT Private Key file to the UA I/O module.</p> <ul style="list-style-type: none"> File format must be PEM. Extension name must be “key”.
MQTT Setting > Certificate – Remove the file	
Trusted Certificate	Click “Remove” to delete all Trusted Certificate files in the UA I/O module.
Certificate	Click “Remove” to delete all Certificate files in the UA I/O module.
Private Key	Click “Remove” to delete all Private Key files in the UA I/O module.

4.5 Main Menu – Advanced Setting

This main menu aggregates the advanced settings, such as the Scaling setting that function can convert the analog signal to a more readable value. The scaling function is only available for AI/AO channels. ICP DAS will develop more advanced functions in the future.

4.5.1 Logic Control

4.5.1.1 Rule Settings

Function: The Rule Setting function provides simple logic condition rule setting, let UA I/O do automatic condition judgment and action control, to achieve simple AI.

Support Module: All UA I/O modules support this function.

Manu Path: 【Advanced Setting】 → 【Logic Control】 → 【Rule Settings】



Add Rules: Click on "Add new rule" to go to the settings page.

Figure 128 4-5-2 Rule Information Setting

Table 75 4-5-2 Rule Information Setting

Advanced Setting > Logic Control > Rule Settings - Add new rule> Rule Information Setting	
Name	The rule name auto-given by the system is used for schedule identification. (For the schedule function, refer to 【Advanced Setting】 > 【Schedule】)
Description	A specific description of the rule can be set to improve recognition.
Resident Execution	Check: the rule will be executed 24 hours a day. Default: enabled. Uncheck: the “ Schedule ” has been set. (For Schedule function, refer to 【Advanced Setting】 > 【Schedule】)
Advanced Setting > Logic Control > Rule Settings - Add new rule> Rule Content Setting	
IF	Set the IF Condition statement of the logic rule. The values or status for evaluation criteria: DI, DO, AI, AO, Virtual Point. Conditions Type: AND, OR.
THEN	When the IF Condition is "Yes", execute the THEN setting. Selectable Action: DO, AO, Delay, Virtual Point, I/O Control, and Link-Up.
ELSE	When the IF Condition is "NO", execute the ELSE setting. Selectable Action: DO, AO, Delay, Virtual Point, I/O Control, and Link-Up.

Advanced Setting:

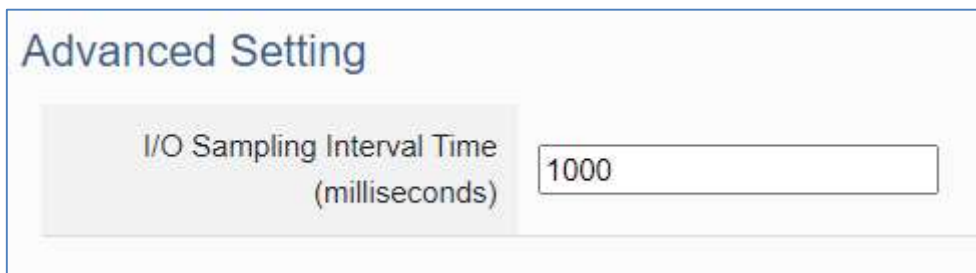

Figure 129 4-5-2 Rule Setting-Advanced Setting

Table 76 4-5-2 Rule Setting-Advanced Setting

Advanced Setting > Logic Control > Rule Settings – Advanced Setting	
I/O Sampling Interval Time (milliseconds)	Enter the interval time (milliseconds) to obtain the value of UA I/O.

4.5.1.2. Scenario Control

Function: Provide UA-I/O series modules to package the I/O points into highly Identifying names. **Must be used with rule setting.**

Support Module: This function is only supported by U-7504M, U-7526M, U-7555M, U-7560M, U-7519ZM, and U-7517M-10.

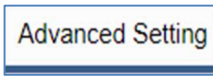
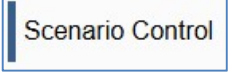
Manu Path: 【Advanced Setting】 → 【Scenario Control】  → 
 (Appendix A).

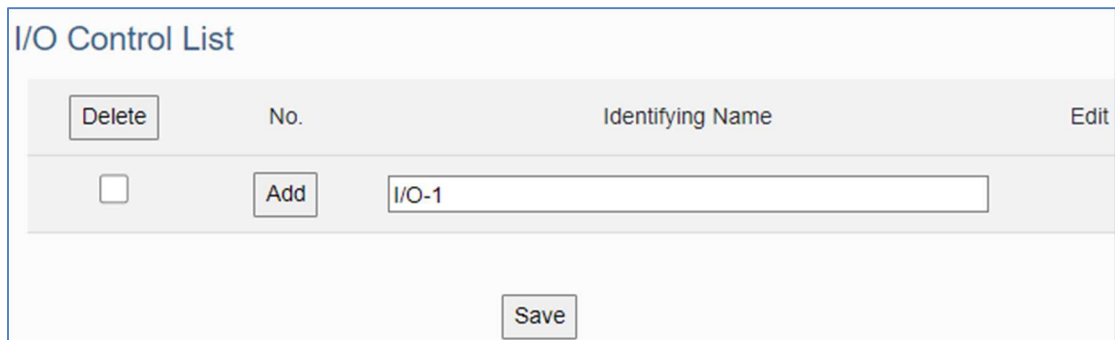

Figure 130 4-5-2-2 I/O Control(1)

Table 77 4-5-2-2 I/O Control

Advanced Setting > Logic Control > Scenario Control	
Delete	Check the box and press the Delete button to delete the item.
No.	The number is automatically given by the system for easy identification.
Identifying Name	Can input Multi-language text. For convenient Rule Setting and recognition. (For the function of Rule Setting, please refer to [Advanced Settings] > [Rule Setting])
Edit	Enter the Edit Setting screen to provide more detailed settings.

Setting method:

1. Fill in the name in the identifying name, for example: I/O-1.
2. Click the "Add" button.
3. Click the "Edit" button of the item to enter the setting page, and set the I/O action of the device.

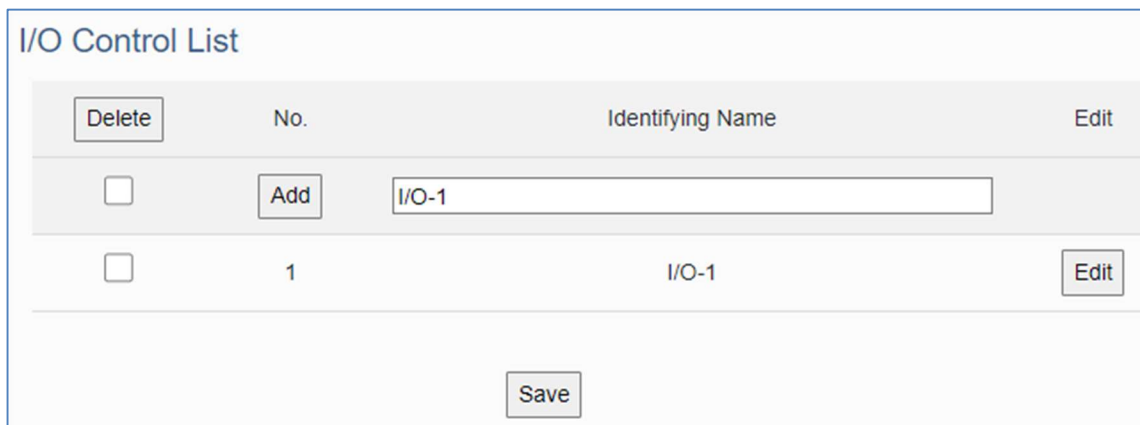

Figure 131 4-5-2-2 I/O Control(2)

Figure 132 4-5-2-2 I/O Control-Setting

Table 78 4-5-2-2 I/O Control-Setting

Advanced Setting > Logic Control > Scenario Control > I/O Control(Edit) > Setting	
Delete	Check the box and press the Delete button to delete the item.
Item	The number is automatically given by the system for easy identification.
DO / AO	According to the module model, select the corresponding I/O.
Value	Set the I/O value. Default: 0.
Depiction	Used to set a more detailed description of the item to improve recognition.

After setting, remember to click OK to return to the I/O control list, and click Save.

4.5.1.3 Schedule

Function: The Schedule function can achieve the timing control for the rule list in Rule Setting.

Support Module: All UA I/O modules support this function.

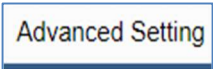
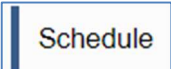
Manu Path: 【Advanced Setting】 → 【Schedule】  →  (Appendix A).

Sample: For a simple setting example, please refer to [Section 3.5](#) .

Note: This webpage will display the rule items (number and name) that have been set in 【Rule Setting】 ; if no rules are set in 【Rule Setting】 , there will not be any list on this page.



Figure 133 4-5-2-3 Schedule-Rule Setting List

Table 79 4-5-2-3 Schedule-Rule Setting List

Advanced Setting > Logic Control > Schedule > Rule Setting List	
No.	The number automatically given by the system corresponds to the number of the 【Rule Setting】 function, users can find it in the menu: 【Advanced Setting】 → 【Rule Setting】 .
Rule Name	The names are the corresponding to the Rule Name of the 【Rule Setting】 function, users can find it in the menu: 【Advanced Setting】 → 【Rule Setting】 → 【Rule Name】 .
Edit	Click “Edit” to enter the editing screen to edit more detailed settings.



Figure 134 4-5-2-3 Schedule-Content Setting

Table 80 4-5-2-3 Schedule-Content Setting

Advanced Setting > Logic Control > Schedule > Rule Setting List (Edit) > Content Setting	
No	The number automatically given by the system. It is the same as the number in the menu: 【Advanced Setting】 → 【Rule Setting】
Rule Name	This name can be modified to a more recognizable name here. It is the same as the rule name in the menu: 【Advanced Setting】 → 【Rule Setting】 → 【Rule Name】 .

Cycle

Week	Start Time			End Time			Display
Sunday	hr	min	sec	hr	min	sec	Disable
Monday	hr	min	sec	hr	min	sec	Disable
Tuesday	hr	min	sec	hr	min	sec	Disable
Wednesday	11	45	0	12	30	0	11:45:0~12:30:0 Enable
Thursday	hr	min	sec	hr	min	sec	Disable
Friday	hr	min	sec	hr	min	sec	Disable
Saturday	hr	min	sec	hr	min	sec	Disable

Specified Range

Delete	No.	Start Time			End Time		
<input type="checkbox"/>	Add	Year	Month	Day	Year	Month	Day
		Hour	Minute	Second	Hour	Minute	Second

Exclude

Delete	No.	Exclude Date		
<input type="checkbox"/>	Add	Year	Month	Day

Figure 135 4-5-2-3 Schedule-Cycle/Specified Range/Exclude

Table 81 4-5-2-3 Schedule-Cycle/Specified Range/Exclude

Advanced Setting > Logic Control > Schedule > Rule Setting List (Edit) >	
Cycle	The rule is enabled and executed every week. Set the start/end time in any day, it will be automatically enabled.
Specified Range	The rule is enabled and executed within a specific time period. Need to set the Start/End time.
Exclude	Specify the exclude date for not execute the rule. If the above two time settings overlap, set the Exclude Date not to execute the rule. Specify the date to exclude the rule.

4.5.2 I/O Trigger Message

4.5.2.1 Msgs→File(CSV)

Function: When the I/O value changes, record the current I/O value for easy device tracking in the future.

Support Module: All UA I/O modules support this function.

Manu Path: 【Advanced Setting】 → 【I/O Trigger Message】 → 【Msgs→File(CSV)】



Digital Input / Output			
Nickname	OFF to ON (Log Message)	ON to OFF (Log Message)	Enable
DI0	ON	OFF	<input type="checkbox"/>
DI1	ON	OFF	<input type="checkbox"/>
DO0	ON	OFF	<input type="checkbox"/>
DO1	ON	OFF	<input type="checkbox"/>

Figure 136 4-5-1 Event Log-Digital Input/Output

Table 82 4-5-1 Event Log-Digital Input/Output

Advanced Setting > I/O Trigger Message > Msgs→File(CSV) > Interface Setting > Digital Input / Output	
Nickname	The nickname in the function of [Module Setting] → I/O Setting
Off to On (log message)	When I/O is ON, the log file will store this log message. Easy for customers to read.
On to Off (log message)	When I/O is OFF, the log file will store this log message. Easy for customers to read.
Enable	Check this item to enable the event log function for this I/O. Default: not enabled

Analog Input / Output

Nickname	Boundary Value	Log Message	Enable
二樓_A房_電熱水器	Upper Limit Value 1 Lower Limit Value 0 Deadband Value: 1	Upper Limit Log Message Over Message Lower Limit Log Message Below Message Normal Range Log Messages Normal Range Message	<input type="checkbox"/>
2階_B室_電氣溫水器	Upper Limit Value 1 Lower Limit Value 0 Deadband Value: 1	Upper Limit Log Message Over Message Lower Limit Log Message Below Message Normal Range Log Messages Normal Range Message	<input type="checkbox"/>

Figure 137 4-5-1 Event Log-Analog Input/Output

Table 83 4-5-1 Event Log-Analog Input/Output

Advanced Setting > I/O Trigger Message > Msgs→File(CSV) > Interface Setting > Analog Input / Output	
Nickname	The Nickname in the function of [Module Setting] → [I/O Setting]
Boundary value	Upper limit: Above the upper limit, it is considered abnormal. Preset: 1
	Lower limit: Below the lower limit, it is considered abnormal. Preset: 0
	Deadband: Dead zone, inactive zone. Set the Deadband value for the floating point data update. Default: 1 (Refer to Appendix C)
Log message	Upper log message: Above the upper limit, this log message is recorded.
	Lower log message: Below the upper limit, this log message is recorded.
	Normal range log message: This log message is recorded between the upper limit value and the lower limit value (only recorded once).
Enable	Check this item to enable the event log function for this I/O. Default: not enabled

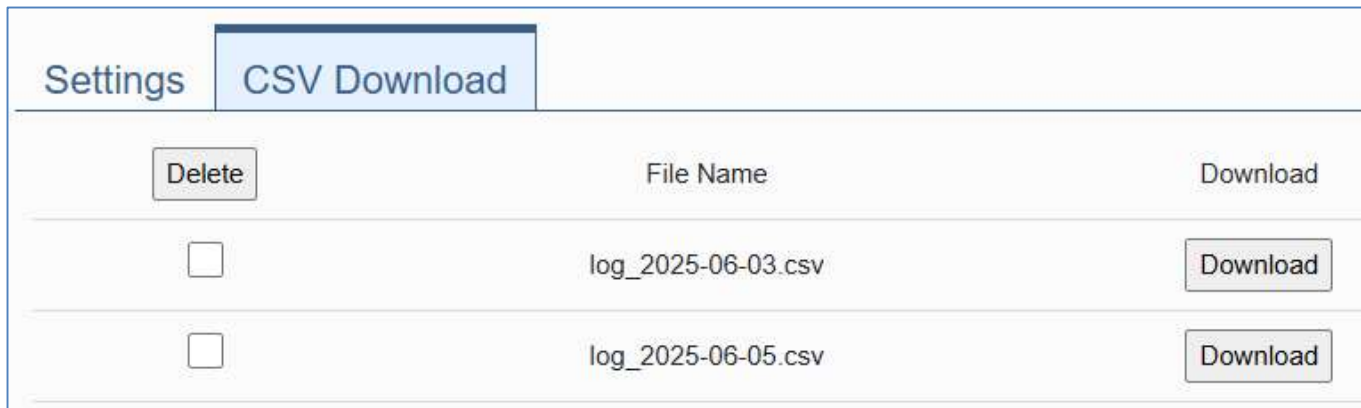

Figure 138 4-5-1 Event Log-Log File Download

Table 84 4-5-1 Event Log-Log File Download

Advanced Setting > I/O Trigger Message > Msgs→File(CSV) – CSV Download	
File Name	The file name is composed of year, month, day, hour, minute, and second. This time is the time of the first content.
Download	Click this button to download the log file.

4.5.2.2 Msgs→Line

Function: When the I/O value changes, the I/O value is sent to Line as an alarm notification.

Module Support: All UA I/O modules support this function.

Manu Path: 【Advanced Setting】 → 【I/O Trigger Message】 → 【Msgs→Line】



Before using, please make sure that [the main setting](#) is checked and enabled

- **Line message sending test**

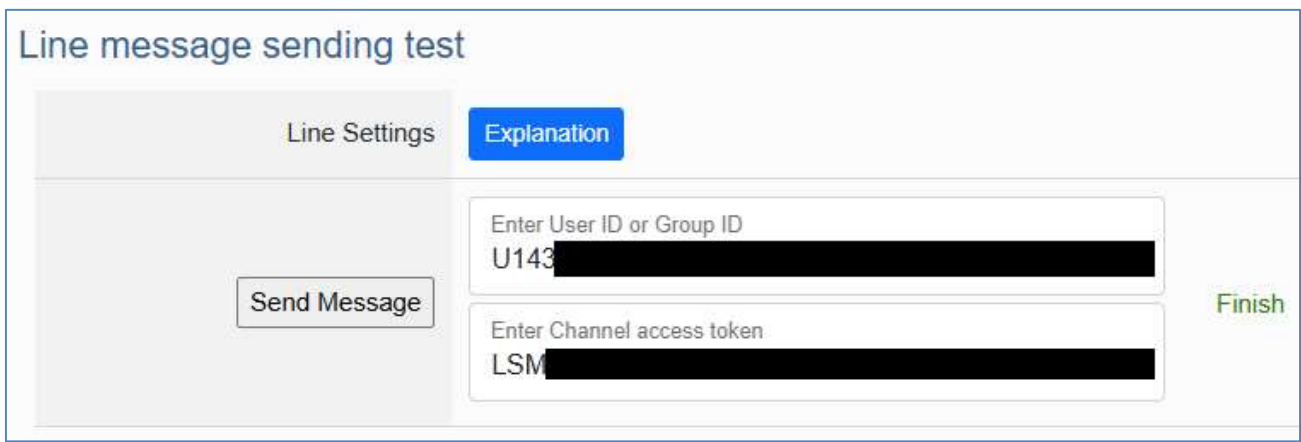

Figure 139 4-5-1-2 Line message sending test

Table 85 4-5-1-2 Line message sending test

Advanced Setting > Event Log > Send messages To Line – Line message sending test	
Line Settings	Click the “Explanation” button for the “Line Official Account Settings”. Obtain the ID and Channel Access Token according to the document instructions.
Send Message	Enter the ID and channel access token in the column and click "Send Message". When the message is successfully sent, “Finish” will be displayed.

- **Event Log + Line Settings**

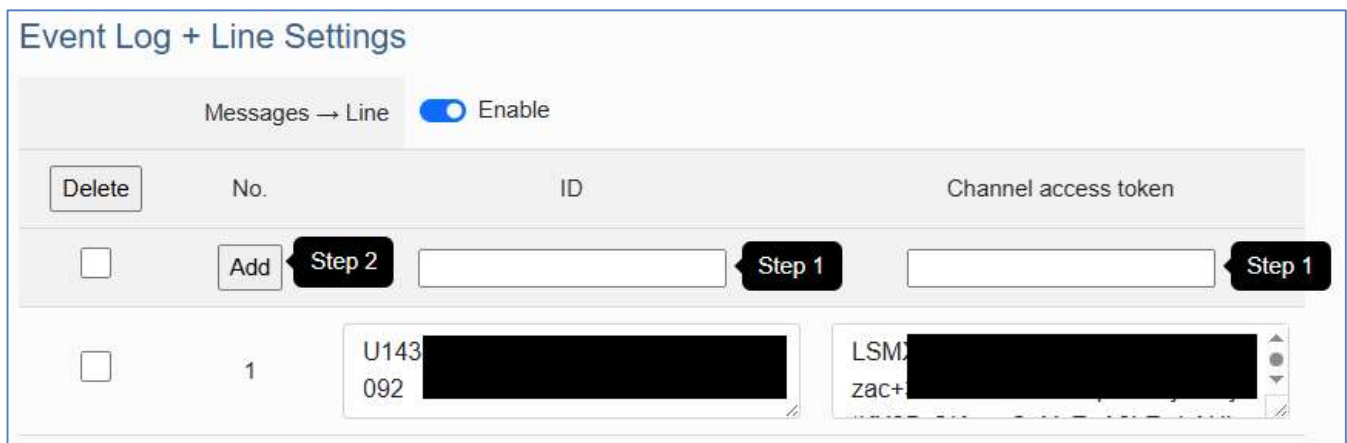

Figure 140 4-5-1-2 Event Log + Line Settings (1)

Table 86 4-5-1-2 Send messages To Line – Event Log + Line Settings

Advanced Setting > Event Log > Send messages To Line – Event Log + Line Settings	
Send Messages To Line	Enable the function to allow the module to send messages to Line.
Delete	Check this item and click the Delete button to delete the item.
No.	The number is automatically given by the system for identification.
ID	The ID obtained from the Line website links the module to the Line.
Channel access token	Channel access token obtained from the Line website links the module to the Line.

How to use Line setting:

1. Enter the ID and Channel access token obtained from the official Line website.
2. Click the "Add" button.
3. Click the "Save" button.

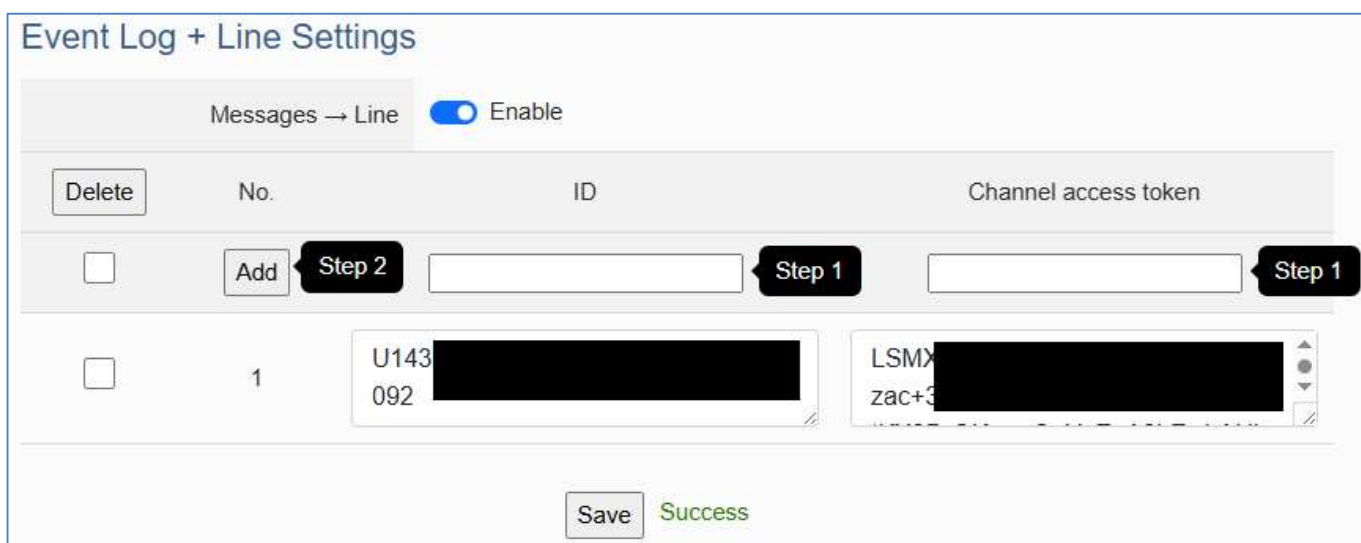

Figure 141 4-5-1-2 Event Log + Line Settings (2)

4.5.3 IoTstar Setting

Function: The IoTstar Setting function can connect to ICP DAS IoTstar cloud IoT management software.

Support Module: All UA I/O modules support this function.

Manu Path: 【Advanced Setting】 → 【IoTstar Setting】 

([Appendix A](#)).

Sample: For a simple setting example, please refer to [Section 3.6](#) .

Currently supported features:

1. Through ICP DAS IoTstar management software, remote operating the web settings.
2. Through ICP DAS IoTstar management software, remote operating the web I/O status reading.
3. Through ICP DAS IoTstar management software, remote operating the web firmware update.
4. Through ICP DAS IoTstar management software, display Real-time I/O data.
5. Through ICP DAS IoTstar management software, display Historical I/O data.
6. Through ICP DAS IoTstar management software, the meter version can control DO, AO value remotely.
7. I/O data of U-7500M → Access to the database via ICP DAS IoTstar management software.

Note: When operating the web interface, please keep only one user in the web interface.

Connection Setting

Server IP	<input type="text" value="iotstardemo.icpdas.com"/>
Server Port	<input type="text" value="1234"/>
Username	<input type="text" value="iotstar_rd9"/>
Password	<input type="password" value="*****"/>
Nickname	<input type="text" value="U-7500M"/>
FTP Port	<input type="text" value="1231"/>
History Data Intervals (Seconds)	<input type="text" value="60"/>
KEY (8 characters)	<input type="password" value="*****"/>
IV (8 characters)	<input type="password" value="*****"/>
Real-Time I/O Data	<input type="checkbox"/> Enable
Historical I/O Data	<input type="checkbox"/> Enable

Figure 142 4-5-3 IoTstar Setting-Connection Setting

Table 87 4-5-3 IoTstar Setting-Connection Setting

Advanced Setting > IoTstar Setting > Connection Setting	
Server IP	The IP address or domain name of the IoTstar.
Username	Enter the account username registered with the IoTstar.
Password	Enter the password registered with the IoTstar.
Nickname	Default: U-7500M. This item is the title name of the IoTstar Device List.
Historical Data Interval	Default: 60 This item is the interval time for sending I/O historical data to IoTstar.
Real-time I/O information	Allows all UA-I/O data to be sent to IoTstar. Factory default: Not enabled.
Historical I/O information	When enabled, the UA-I/O data is temporarily stored in the module and sent to IoTstar. Factory default: Not enabled.

4.5.4 EZ-UAQ Utility

Function: Settings related to the EZ-UAQ Utility network management tool.

Support Module: All UA I/O modules support this function.

Manu Path: 【Advanced Setting】 → 【EZ-UAQ Utility】 

(Appendix A).

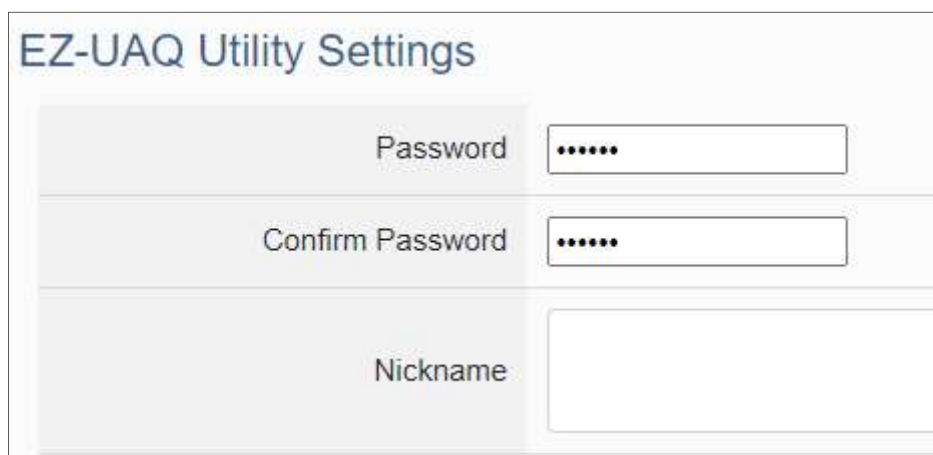

Figure 143 4-5-4 EZ-UAQ Utility Settings

Table 88 4-5-4 EZ-UAQ Utility Settings

Advanced Setting > EZ-UAQ Utility	
Password	Set a password to restrict the authorization of the EZ-UAQ Utility. When the EZ-UAQ Utility gets the same password, you can control the module.
Confirm Password	Retype the password for the operation conform when setting the new account information.
Nickname	The nickname can be seen in the 【Advanced Setting】 → 【EZ-UAQ Utility】 . It is convenient for users to identify the module.

5. Recovering Firmware Setting (Reset)

This chapter explains how to use the Reset button to recover the firmware settings, **please wait for ten minutes.**

The steps are as follows:

1. Please find the **Reset** button on the UA I/O bottom side, and then press the **Reset** button.



Figure 144 5 Recovering Firmware Setting(1)

2. When starting the recovering process, all the LEDs on the panel will light up red or green.



Figure 145 5 Recovering Firmware Setting(2)

3. If all LEDs light on red, it indicates an error. When this happens, please press the Reset button again.

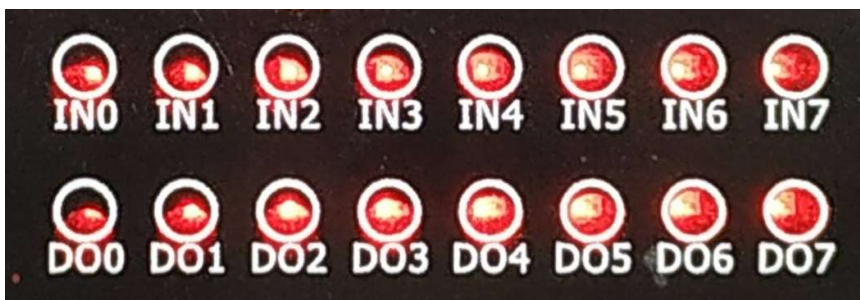

Figure 146 5 Recovering Firmware Setting(3)

4. If all LEDs light on green, it means the recovering process is successful.



Figure 147 5 Recovering Firmware Setting(4)

5. After restarting, the module will recover the UA I/O settings as follows:

Table 89 5 Recovering Firmware Setting

Recovering Firmware of UA I/O Modules			
Network	IP (LAN)	Keep the original setting	Assign UA I/O a new IP setting according to your case.
	Mask	Keep the original setting	
	Gateway	Keep the original setting	
Web UI Account	Username	root	After login, change the default username/password to use other functions.
	Password	root	

Appendix A. Menu Path Diagram Description

【Menu Path】 diagram shows the main menu function section path in a brief way that user can follow the menu path order (text/diagram) to select the main menu and the sub-menu, then can go to the function setting web page. Please see the examples below for detail description.

[Example 1] Description for the menu path of 【System Setting】 → 【Overview】 :

1. Click 【System Setting】 function of main menu on the upper side, such as System Setting .
2. Click 【Overview】 function of sub-menu appeared on the left side, such as Overview .
3. Check or set up the information or function items on the setting area of the 【Overview】 .

Menu Path : System Setting → Overview

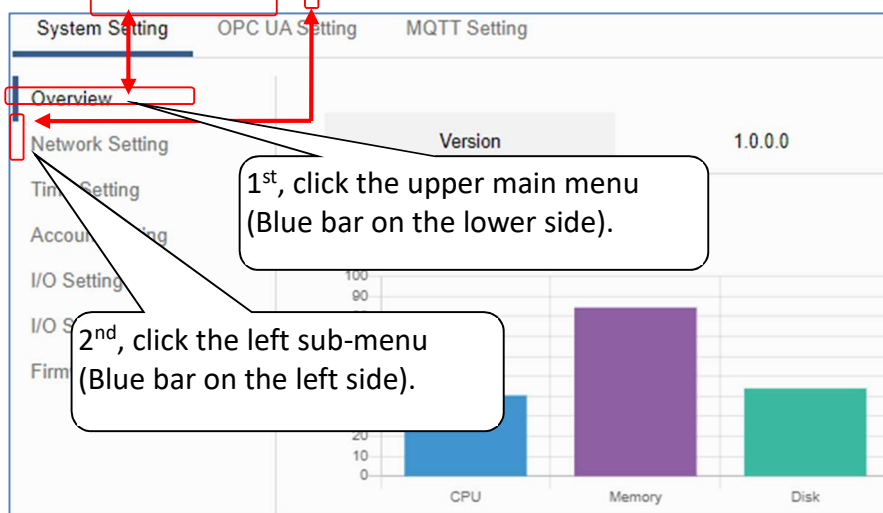

Figure 148 Appendix A. Menu Path Diagram Description (example 1)

[Example 2] Description for the menu path of 【OPC UA Setting】 → 【Certificate】 :

1. Click 【OPC UA Setting】 function of main menu on the upper side, as below.
2. Click 【Certificate】 function of sub-menu appeared on the left side, as below.
3. Set up the function items on the setting area of the 【Certificate】 .

Menu Path : OPC UA Setting → Certificate

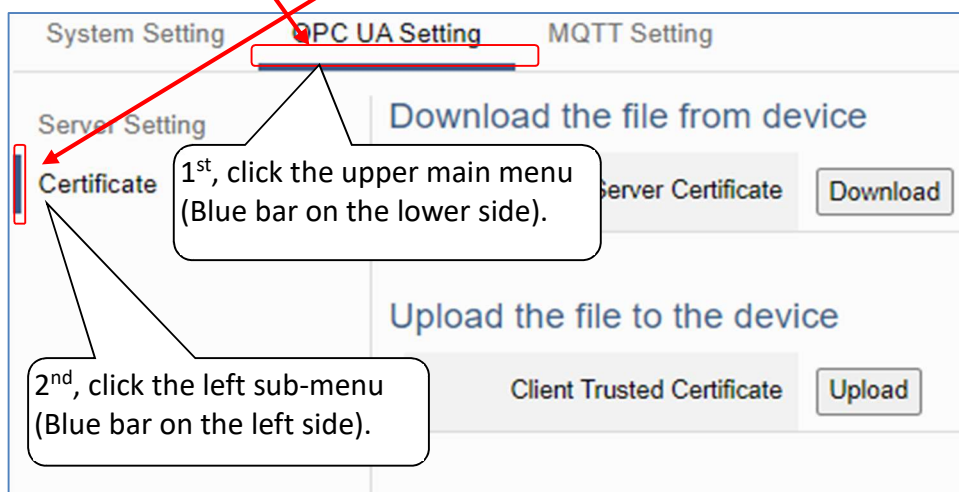

Figure 149 Appendix A. Menu Path Diagram Description (example 2)

Appendix B. MQTT JSON Format of the UA I/O Series

MQTT JSON Example & Format Descriptions for the U-7526M:

```
{
  "DO0": 0,
  "DO1": 0,
  "DI0": 0,
  "DI1": 0,
  "Vout0": 4.999,
  "Vout1": 4,
  "Vin0": 5.003,
  "Vin1": -32.768,
  "Vin2": -32.768,
  "Vin3": 0,
  "Vin4": 0,
  "Vin5": 0,
  "DI0_Counter": 0,
  "DI1_Counter": 0,
  "DI0_Preset": 0,
  "DI1_Preset": 0,
  "DI0_CounterClear": 0,
  "DI1_CounterClear": 1,
  "Scale_Vout0": 34.997,
  "Scale_Vout1": 32,
  "Scale_Vin0": 35.009,
  "Scale_Vin1": -78.304,
  "Scale_Vin2": -78.304,
  "Scale_Vin3": 20,
  "Scale_Vin4": 20,
  "Scale_Vin5": 20
}
```

Table 90 Appendix B. MQTT JSON Format of the UA I/O Series

Name	Description
Left column (such as DO0, DO1...etc.)	the name of the variable. It will change according to the module.
Right column	The value of the variable.

Method 1 to get the variable name: Login to the web interface

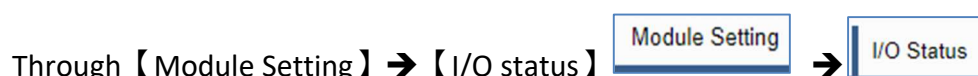

Channel items can be obtained.

Digital Input

Channel	Nickname	Value	Status
DI0	DI0 tim	<input type="checkbox"/>	GOOD
DI1	DI1 tim	<input type="checkbox"/>	GOOD
DI0_Counter	DI0 tim_Counter	0	GOOD
DI1_Counter	DI1 tim_Counter	0	GOOD

Method 2 to get the variable name: Login to the web interface



For common settings, click the download button. You can get

[CommonSettings.csv](#)

I/O Channel items can be obtained.

I/O Channel	Nickname	JSON Format Enable	Publish Top	Publish QoS	Subscribe T	Subscribe C	Retain
DI0	DI0	TRUE	/Name/Publ	2	/Name/Subs	2	TRUE
DI0_Counter	DI0_Counter	TRUE	/Name/Publ	2	/Name/Subs	2	TRUE
DI0_CounterClear	DI0_CounterClear	TRUE	/Name/Publ	2	/Name/Subs	2	TRUE
DI0_Preset	DI0_Preset	TRUE	/Name/Publ	2	/Name/Subs	2	TRUE
DI1	DI1	TRUE	/Name/Publ	2	/Name/Subs	2	TRUE
DI1_Counter	DI1_Counter	TRUE	/Name/Publ	2	/Name/Subs	2	TRUE
DI1_CounterClear	DI1_CounterClear	TRUE	/Name/Publ	2	/Name/Subs	2	TRUE
DI1_Preset	DI1_Preset	TRUE	/Name/Publ	2	/Name/Subs	2	TRUE
DO0	DO0	TRUE	/Name/Publ	2	/Name/Subs	2	TRUE
DO1	DO1	TRUE	/Name/Publ	2	/Name/Subs	2	TRUE
Vin0	Vin0	TRUE	/Name/Publ	2	/Name/Subs	2	TRUE
Vin1	Vin1	TRUE	/Name/Publ	2	/Name/Subs	2	TRUE

Figure 150 Appendix B. MQTT JSON Format of the UA I/O Series

Appendix C. Dead Band Description

(B) If select **AIO Variable**, then Condition is “Value” and can set the “Dead Band”. The condition will be triggered and send the message when the detected value exceeds the upper or lower Dead Band. (Below is a CO2 example. Detect per 500 ms)

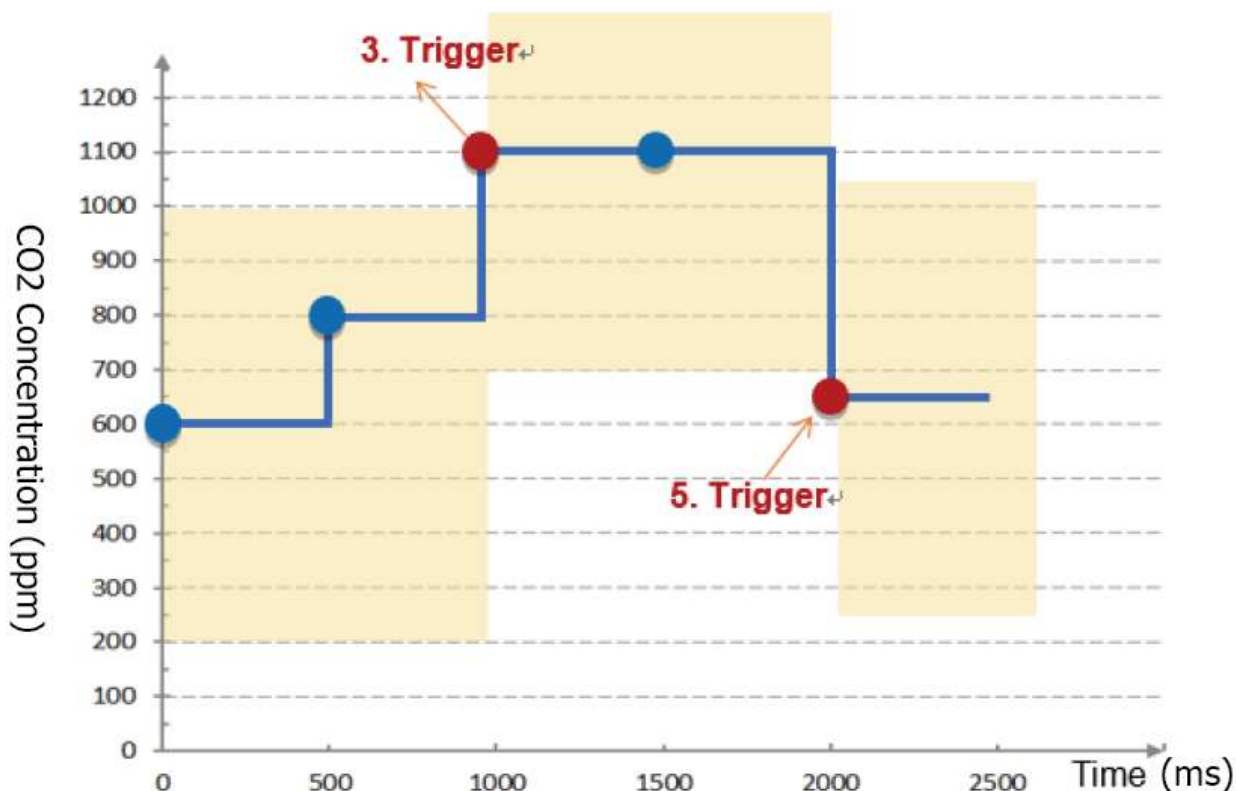

Figure 151 Appendix C. Dead Band Description

AIO Trigger: (Detect per 500 ms the yellow block means the Dead Band)

1. Detect initial CO2 concentration 600 (ppm)
Set Dead Band=400 (Initial Trigger Condition: ≥ 1000 or ≤ 200)
2. Detect CO2 concentration 800. It is in the range of Dead Band.
3. Detect CO2 concentration 1100. It exceeds the upper value (≥ 1000) of Dead Band, so **trigger** a message for danger notification.
4. Detect CO2 concentration 1100. It is in the new range of Dead Band.
Dead Band=400 (New Trigger Condition: ≥ 1500 or ≤ 700)
5. Detect CO2 concentration 650. It is below the lower value (≤ 700) of Dead Band, so **trigger** a message for safety notification.